

**On the Possibility of Investigations
with Very Cold Neutrons
at Pulsed Sources**

Yu.N. Pokotilovski

FLNP, JINR, Dubna, Russia

The possibility is considered of investigations with very cold neutrons (VCN) at pulse neutron sources. As a testing area the 3rd channel of IBR-2 is proposed. Possible application areas and the reactor characteristics for these investigations are shortly described. The results of detailed calculations of the VCN generation in different cold moderators, VCN transport in neutronguides and of suppression of contribution of delayed neutrons are presented.

VCN ($\lambda > 10 \text{ \AA}$) would better provide for studying matter
in big scales (100-1000 \AA) and at big times.

Experimental techniques:

- time-of-flight spectroscopy
- spin-echo
- SANS
- reflectometry
- diffraction

Advantages and new possibilities

- Slow motions with characteristic energy of the VCN range are typical in complicated molecular complexes and in "soft matter".
- Scattering cross section on clusters $\sim \lambda^2$, this increases possibilities of investigations of nano-materials.
- Long wavelength neutron diffraction may be used in structural analysis of big molecular complexes, e.g. biological nature.
- Neutron microscopy and holography are possible only at intense VCN fluxes.
- Larger neutron capture cross section leads to larger contrast absorption/transmission, this is advantageous in the neutron tomography.

Neutron optical instruments can work better at long wavelengths due to larger difference of the refraction index from unity:

$$(1 - n) \approx (\lambda/\lambda_c)^2; \quad \lambda_c = (\pi/Nb)^{1/2}.$$

In neutron optics:

- The total reflection angle $\sim \lambda$, this gives better reflection from mirrors, from supermirrors with large m up to angles 10-20 degrees.
- The prism deflection angle $\sim \lambda^2$, wide angle beams can be better focused with mirrors and lenses at lower lengths: the focal length $\sim \lambda^{-2}$.
- Due to larger neutron phase shift in matter and magnetic field ($\sim \lambda$) the VCN are better sensitive to small contrast – neutron tomography of thin samples is possible.
- In neutron interferometry large coherence length: longitudinal and transverse one are better realized in the long wavelength region.



THE UNIVERSITY OF
CHICAGO



Argonne National Laboratory is managed by
The University of Chicago for the U.S. Department of Energy



ANL-05/42

Proceedings of the Workshop on
Applications of a Very Cold Neutron Source

Proceedings of the Workshop on Applications of a Very Cold Neutron Source

August 21-24, 2005

prepared by
Intense Pulsed Neutron Source Division
Argonne National Laboratory



ANL-05/42

Argonne National Laboratory is managed by
The University of Chicago for the U.S. Department of Energy

Present Status and Future of Very Cold Neutron Applications

13-14 February 2006 Paul Scherrer Institute - Switzerland.

The aim was to discuss the perspectives of using very cold neutrons 15-100 Å or larger wavelength in condensed matter research and fundamental physics.

New developments in very cold moderation and phase space transformation methods indicate that an increased VCN flux might be available in the near future which could be used in neutron-based science.

A previous workshop has been held 21-24 August 2005 at IPNS-ANL – [Proceedings](#).

IBR-2 characteristics.

Frequency 5 Hz: at the path length 10-12 m it is possible to reach $\lambda \sim 40 \text{ \AA}$, without overlapping.

Thermal neutron pulse width ($\sim 350 \mu\text{s}$) is large for the time-of-flight spectrometry in thermal and cold energy range and demands additional devices, e.g. Fourier choppers.

For the VCN range this pulse width is optimal: the VCN escape time from optimized VCN cold moderators is of the same order, at the path length 10-15 m it is possible to have tof resolution $\sim 5 \mu\text{eV}$.

Pulsed thermal neutron sources.

Name, state	$\Phi_{max}, n/cm^2/s$	$\delta t, \mu s$	frequency, s^{-1}	Pulse fluence, n/cm^2
ISIS I, England	10^{15}	25	50	$\sim 2.5 \times 10^{10}$
ISIS II, England	4.5×10^{15}	25	5	$\sim 1.1 \times 10^{11}$
MLNSC, USA	7×10^{14}	25	20	$\sim 1.75 \times 10^{10}$
SNS, USA	1.2×10^{15}	20-50	60	max 6×10^{10}
STS, USA, project	5×10^{15}	20-200	10	max 10^{12}
JSNS, Japan	$2/6.5 \times 10^{15}$	20-50	25	max 3.25×10^{11}
Donguan, China	$\sim 5 \times 10^{14}$	20-50	25	max 2.5×10^{10}
IBR-2, Russia	$\sim 6 \times 10^{15}$	310	5	1.85×10^{12}
ESS, Sweden, project	$(5-7.5) \times 10^{15}$	2800	14	max 2.1×10^{13}

Yu.N. Pokotilovskij,

“Some Possibilities of Investigations

with Very Cold Neutrons at Pulsed Sources”

JINR Communication P3-84-810, Dubna, 1984 (in Russian).



Рис. 1. Комплекс замедлителей модернизированного реактора ИБР-2. I — холодные замедлители: КЗ201 — в направлении пучков №1, 4-6, 9, КЗ202 — в направлении пучков №7, 8, 10, 11, КЗ203 — в направлении пучков 2, 3; II — активная зона реактора: СО — контролирующие органы реактора; 1-11 — нейтронные пучки

neutron wavelength dependence
of neutron attenuation by 3 m of air

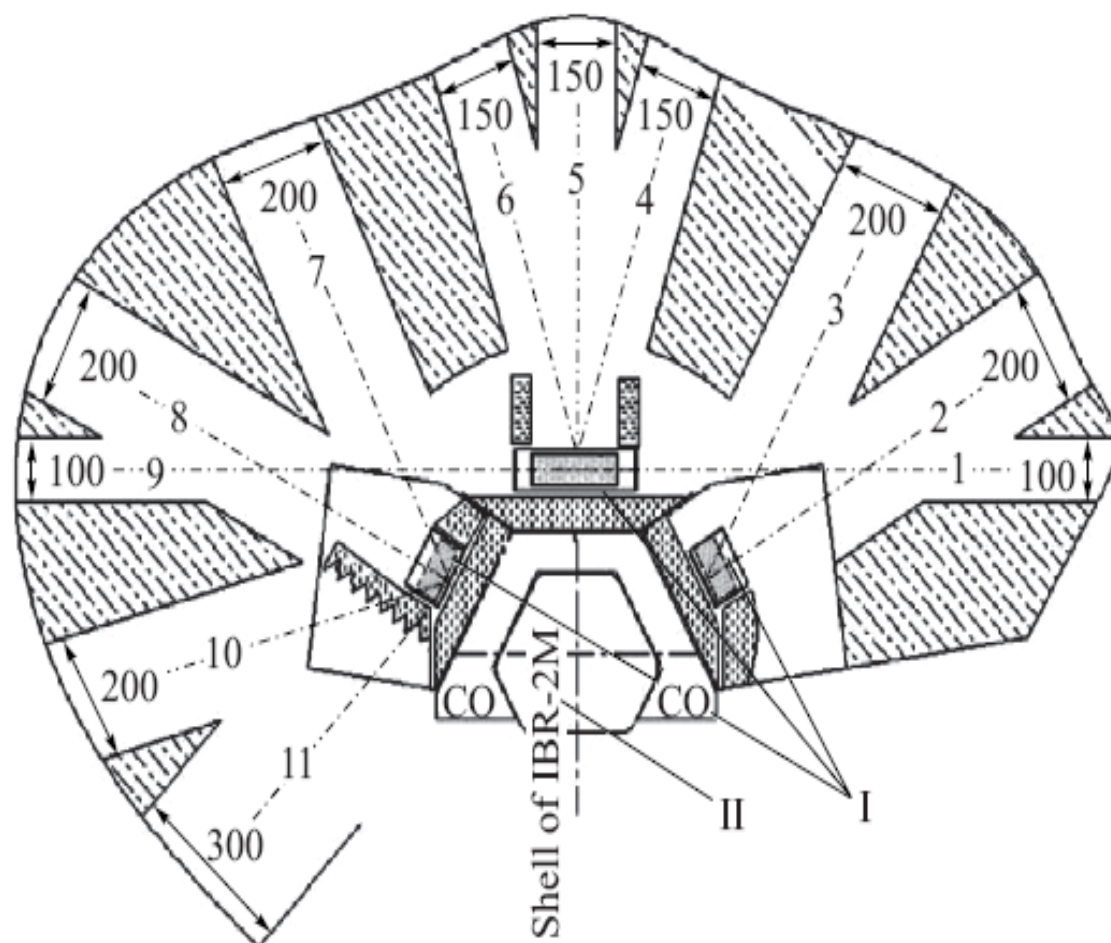
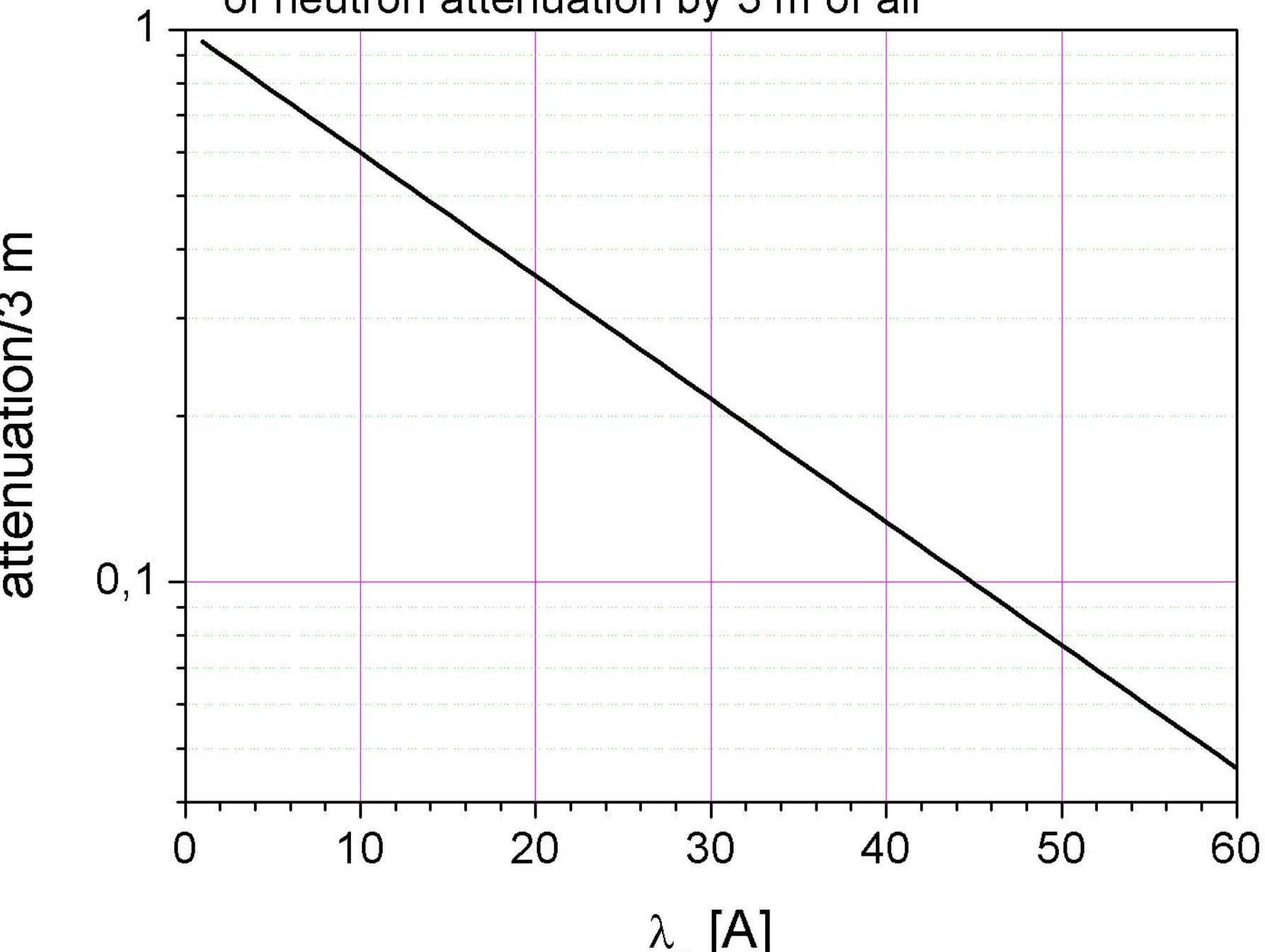

solid CH_4 ($T=22\text{K}$, $\rho=0.26\text{ g/cm}^3$) thickness dependence

of neutron current from moderator surface (F1)

$n/\text{cm}^2/\text{s}/\text{meV}/\text{MW}$

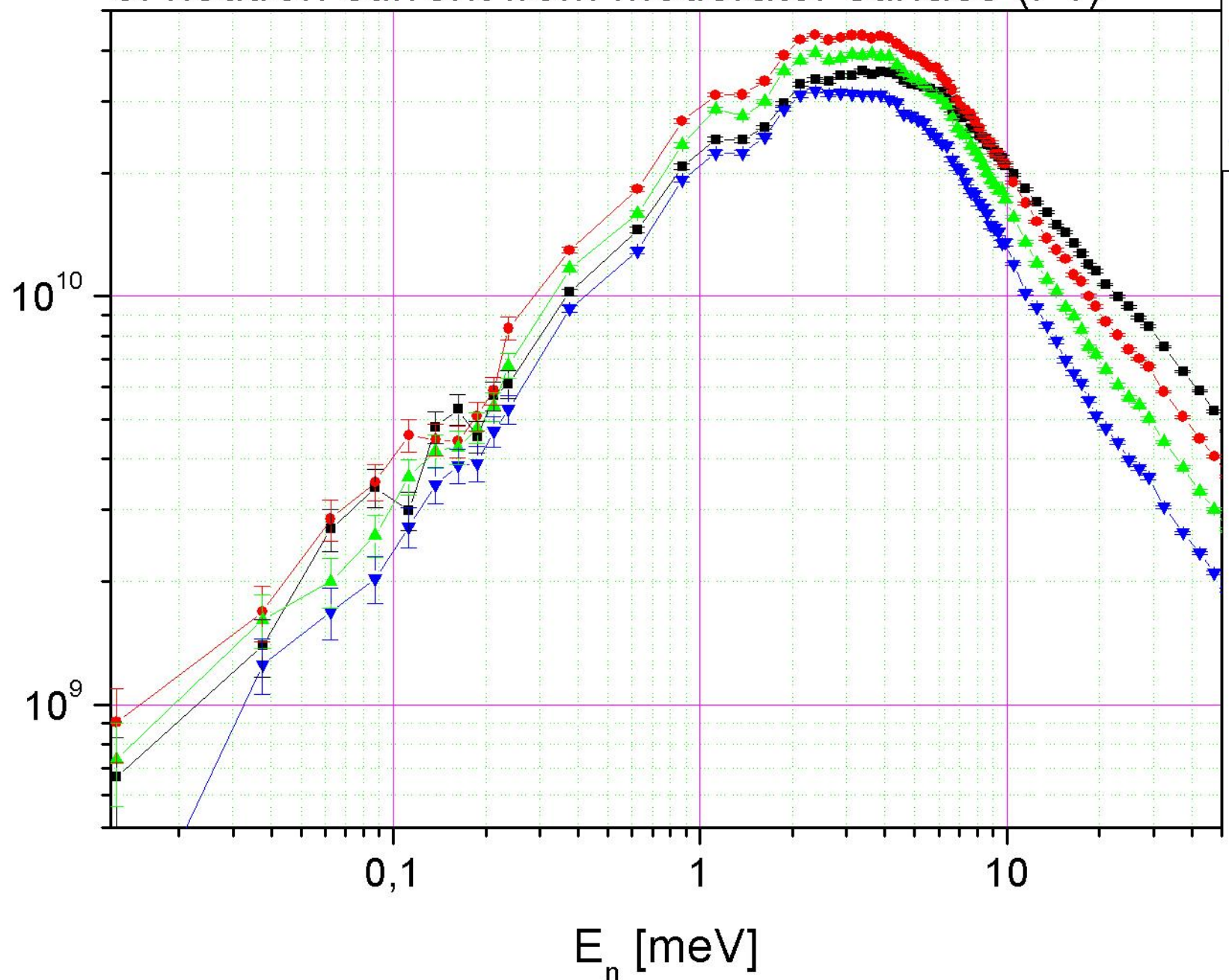

neutron flux from moder. surface (F1), H₂O frame

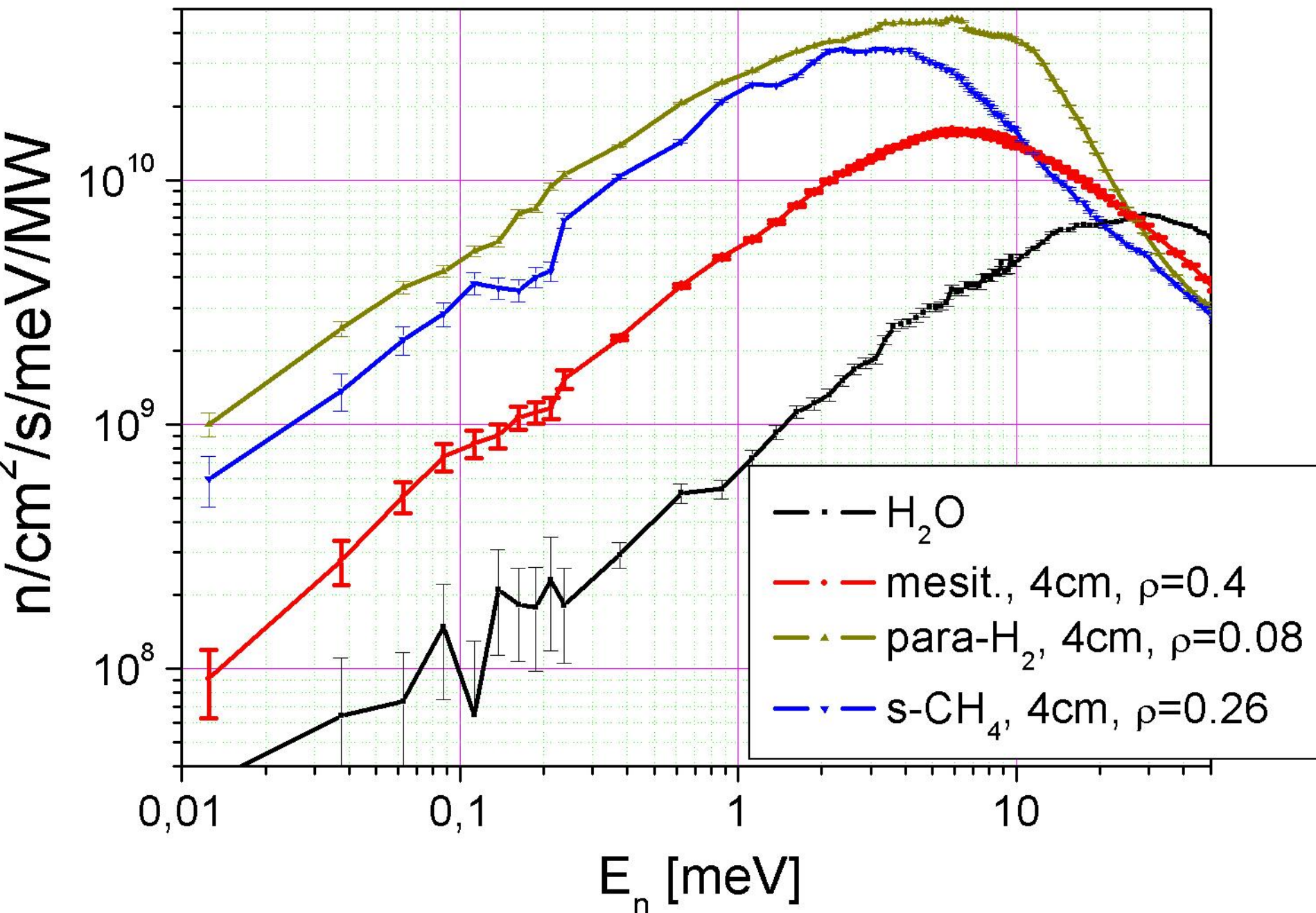

Time-dependence of neutron flow-out
from solid CH₄ moderator (d=4 cm)

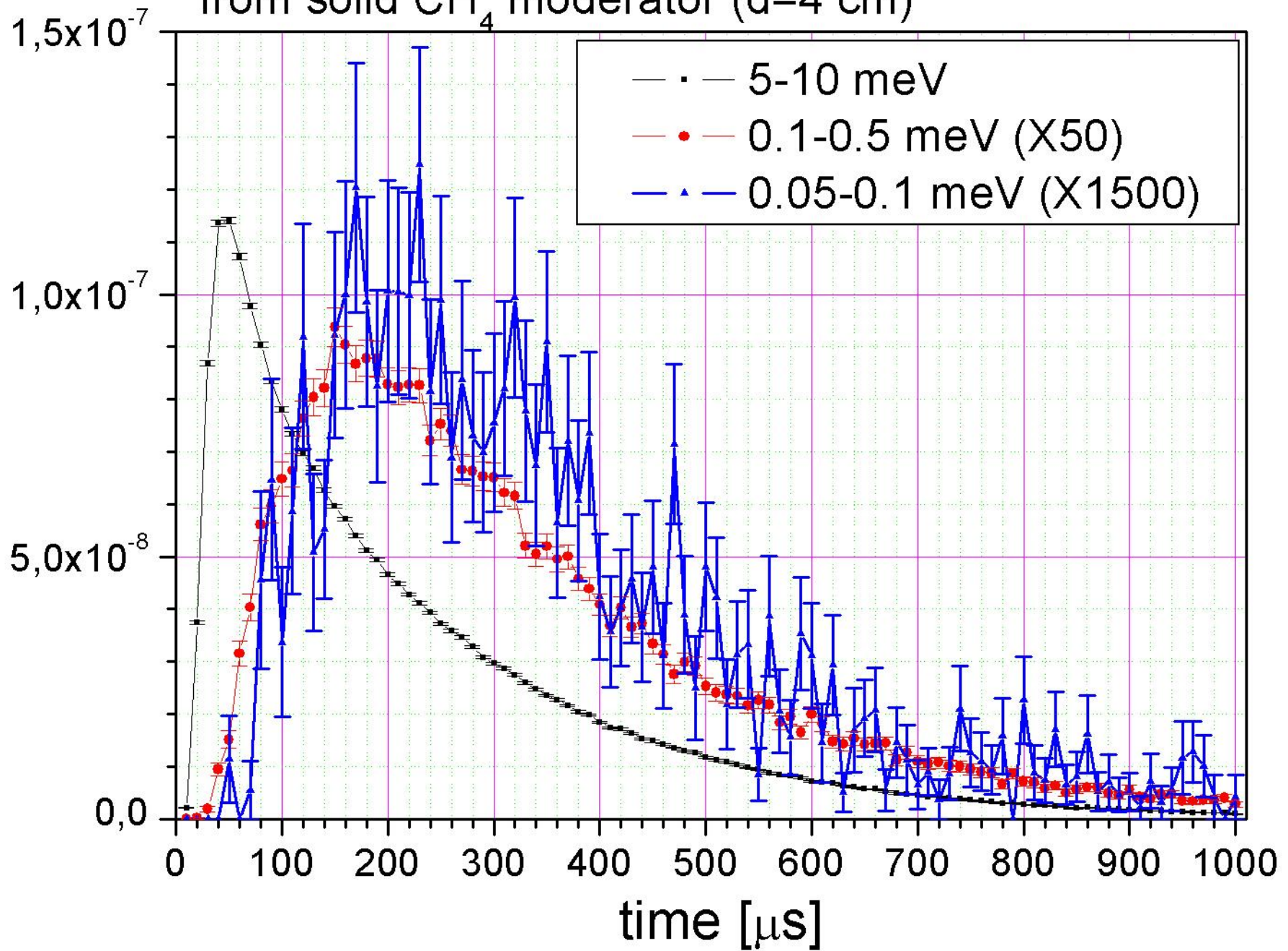

Effect of a guide curvature on the delayed neutrons intensity

$L=8$ m, $a=4$ cm, $h=10$ cm

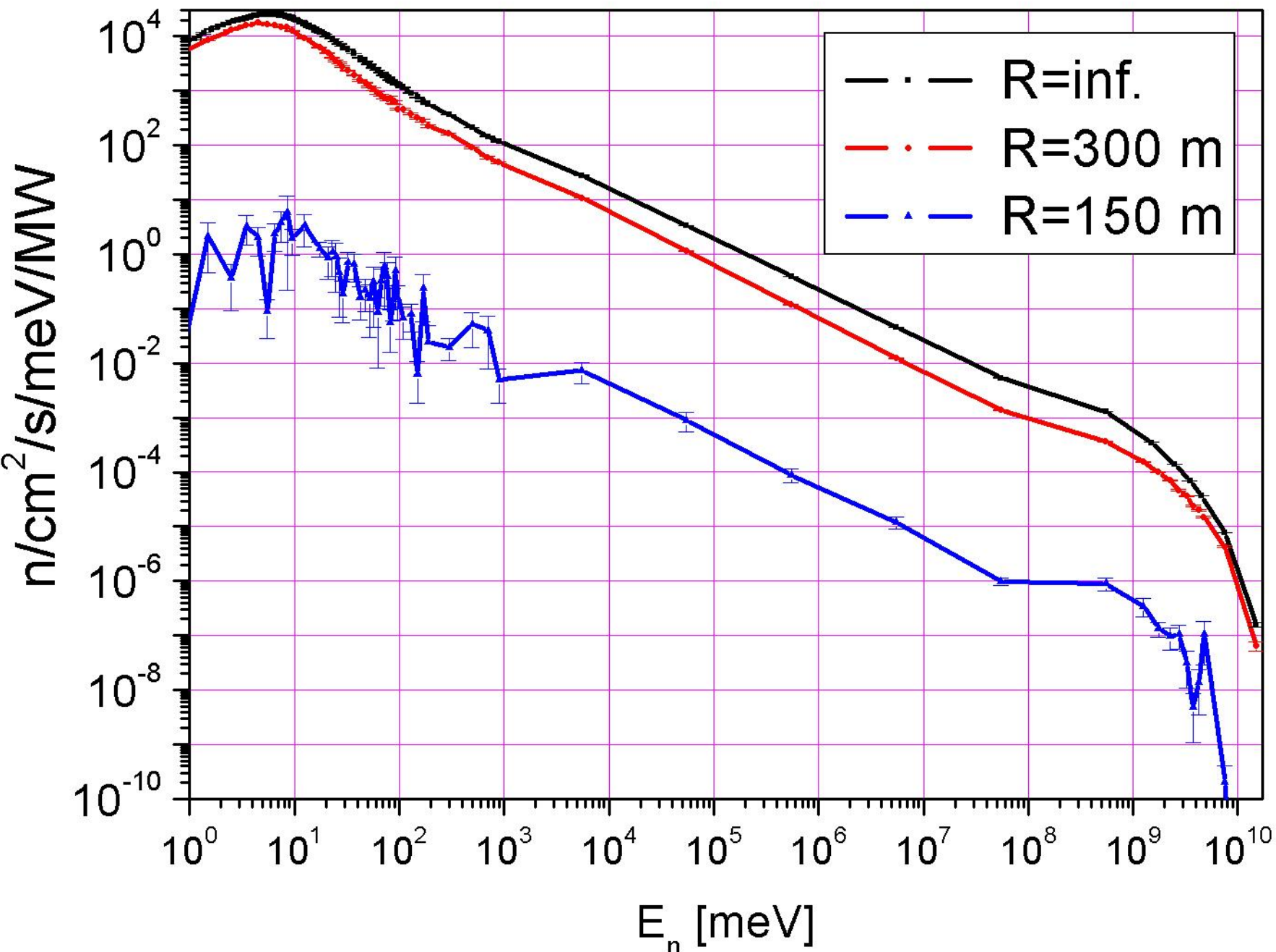

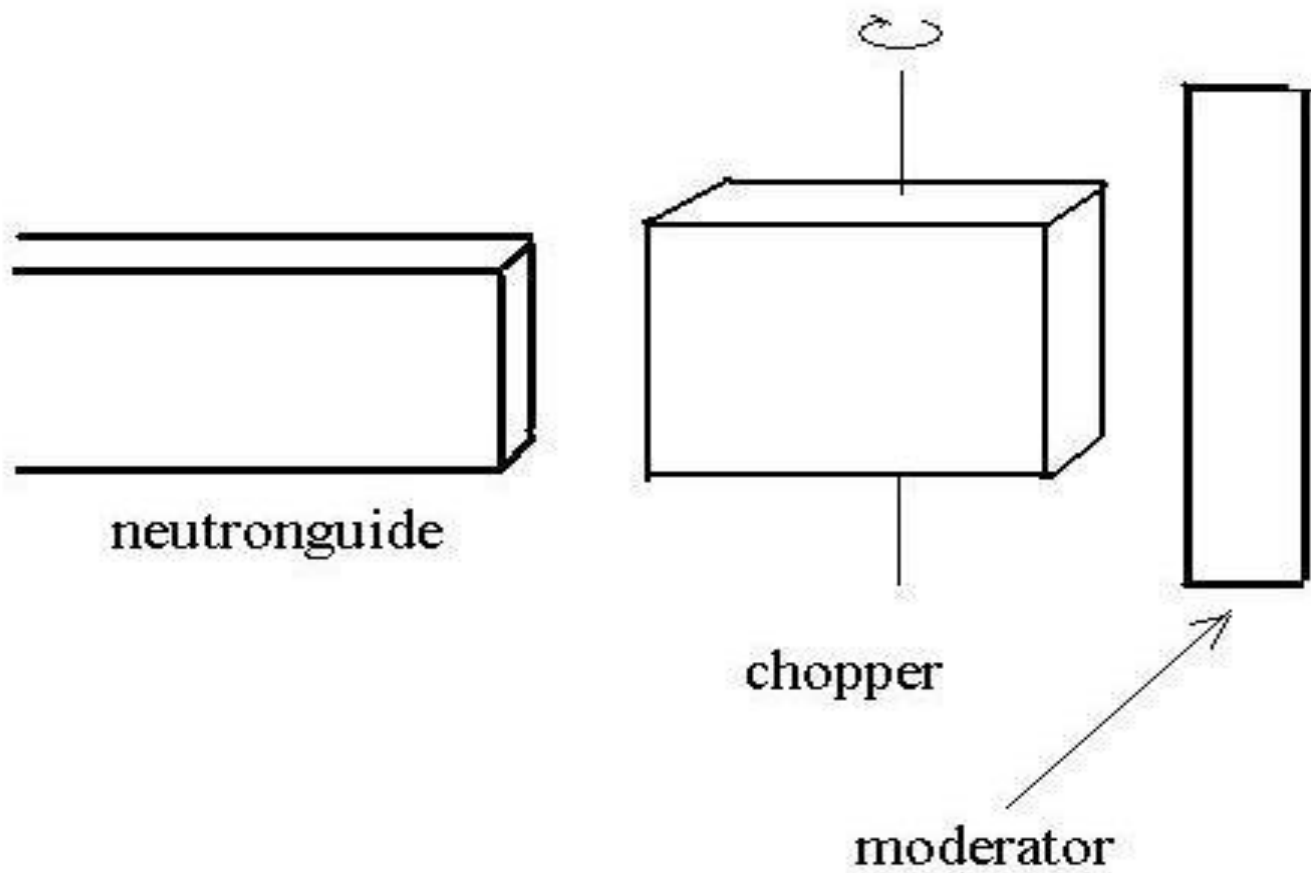

$$a=4 \text{ cm}, E_{\text{norm}}=2 \times 10^{-7} \text{ eV}$$

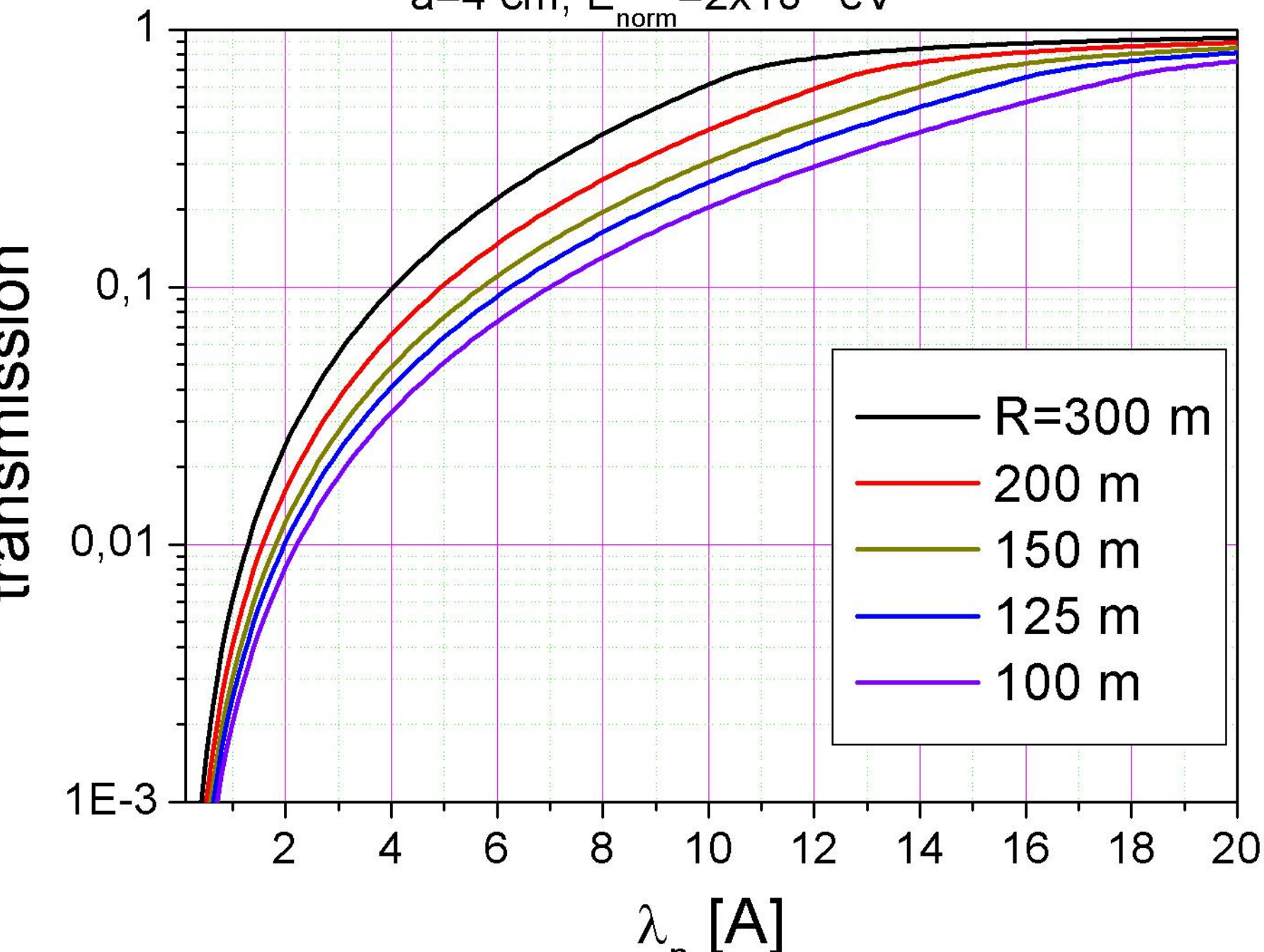

Neutron spectra at the exit of the guide

$L=8$ m, $W=4$ cm, $H=10$ cm, $v_b=6$ m/s

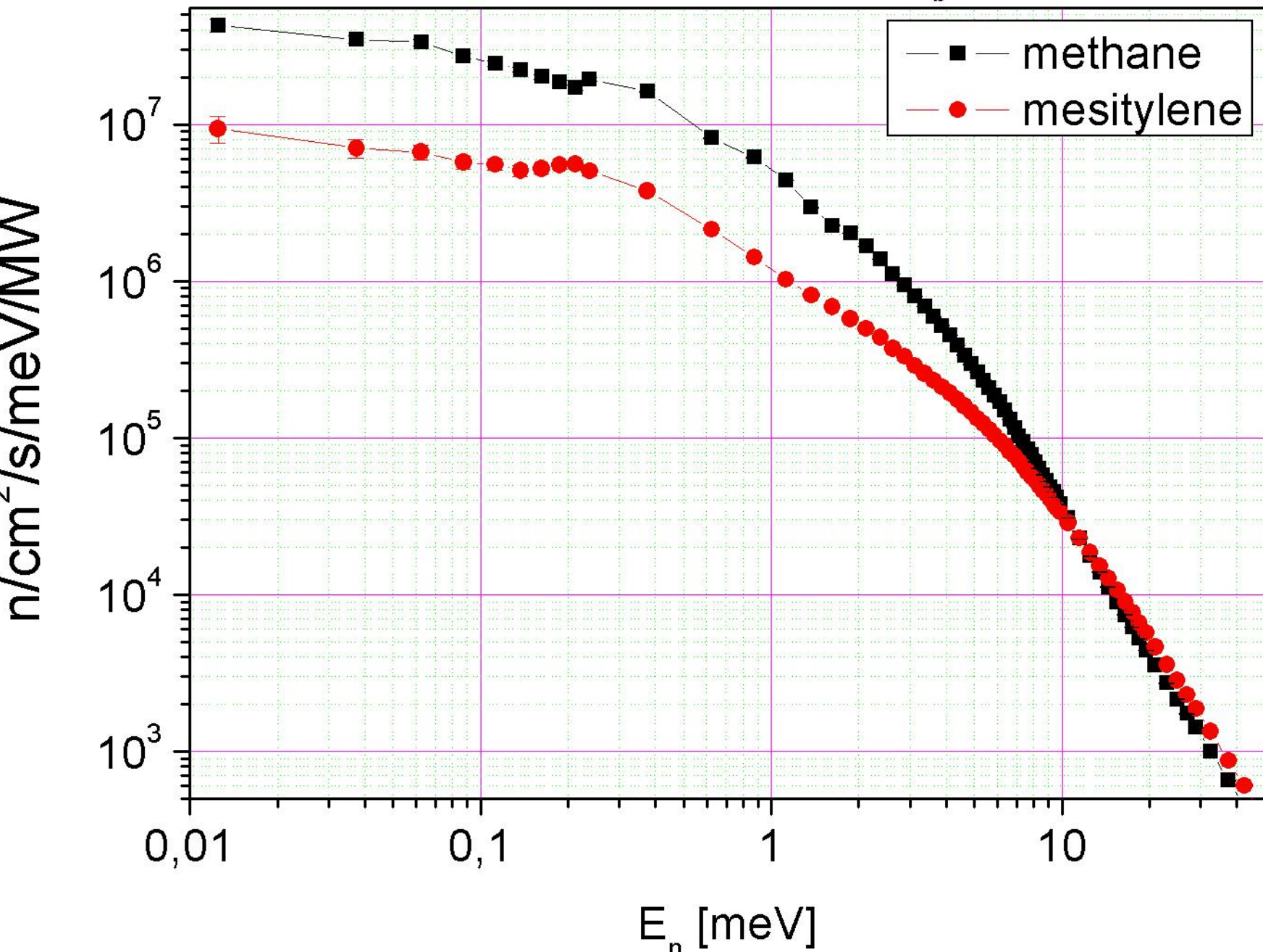

Conclusion

VCN have good potential in neutron scattering and fundamental neutron physics.

Before construction of new FLNP neutron source IBR-2 has good potential for the VCN production and development of the VCN scattering for material science and long wave neutron optics. Properly constructed the VCN guide combined with optimized cold moderator may provide interesting opportunities in development of neutron science in FLNP.

Very cold neutrons as a perspective
tool for fundamental research
and research by neutron scattering

Yu.N. Pokotilovski

FLNP, JINR, Dubna, Russia

The possibility is considered of investigations with very cold neutrons (VCN) at pulse neutron sources. As a testing area the 3rd channel of IBR-2 is proposed. Possible application areas and the reactor characteristics for these investigations are shortly described. The results of detailed calculations of the VCN generation in different cold moderators, VCN transport in neutronguides and of suppression of contribution of delayed neutrons are presented.