



FLNP

Dubna Neutron Source  
of the Fourth Generation  
**SUPERBOOSTER NEPTUN**



JINR

JOINT INSTITUTE FOR NUCLEAR RESEARCH  
FRANK LABORATORY OF NEUTRON PHYSICS

Dubna 2018

**Editors:** V.L.Aksenov and E.P.Shabalin

**Contributors:**

JOINT INSTITUTE FOR NUCLEAR RESEARCH:

V.L.Aksenov, S.N.Dolya, G.G.Komyshchev, Yu.N.Pokotilovsky, E.P.Shabalin,  
A.M.Balagurov, D.M.Chudoba, D.P.Kozlenko, N.Kučerka, S.A.Kulikov, E.V.Lychagin,  
M.V.Rzyanin, V.N.Shvetsov

DOLLEZHAL RESEARCH AND DEVELOPMENT INSTITUTE OF POWER  
ENGINEERING (MOSCOW):

A.V.Lopatkin, I.T.Tretyakov

**Publisher:** JOINT INSTITUTE FOR NUCLEAR RESEARCH

# **Superbooster NEPTUN**

## **Dubna Neutron Source of the Fourth Generation**

# Contents

## Preface

### Scientific opportunities

Condensed matter research

Nuclear physics

Basic research

Flagship experiments

### World neutron landscape

### Why a superbooster

### NEPTUN concept

Design principles

Why Neptunium

Accelerator

Core and heat removal

Reactivity modulator

Moderators and instruments

Nuclear safety

Basic parameters

### Road map and costs

### Appendix

Brief history of Dubna neutron sources

## Preface

The periodic research pulsed fast-neutron nuclear reactor IBR-2 has been successfully operating since 2012 for the second term after its modernization. This third-generation neutron source in Dubna (see Appendix) has the highest peak neutron flux in the world and is currently the only world-class neutron source in JINR Member States for investigations on extracted beams. The service life of the reactor facility and complex of technological equipment is expected to expire in 2032-2037 (depending on operating conditions) and the lifetime of the building is estimated to end in 2042. This raises a number of questions.

First of all, do we need a new source at all, or, in other words, will we need neutrons for beam research in 20-30 years? This seemingly absurd question is not unreasonable. The point is that for the last two decades a number of physical methods for studying the structure and properties of matter have evolved a great deal. This is especially true in regard to synchrotron radiation sources and free-electron X-ray lasers, which offer absolutely fantastic possibilities. Therefore, it is necessary to formulate scientific problems for the solution of which neutrons could provide unique possibilities even in 20-30 years. The analysis of the horizons of neutron studies shows that to solve the posed problems, we need a pulsed source with an average thermal neutron flux density  $\overline{\Phi}_n^T$  of no less than  $10^{14}$  n/(cm<sup>2</sup>·s). Further we will consider this estimate as a lower limit for the new source. In this regard, there is no question about the possibility of using the available project of the operating IBR-2 reactor. The calculations (V.D.Ananiev, Yu.N.Pepelyshev, A.D.Rogov. JINR P13-2017-43, Dubna, 2017) show that the upper limit of the thermal neutron flux density at IBR-2 is limited to  $10^{13}$  n/(cm<sup>2</sup>·s).

The next question is whether a new neutron source will be needed in Europe. This issue is being actively discussed in the leading European neutron centers in various aspects. The conclusion is that after 2030 a severe shortage of neutrons for research is expected, and in this context, it is high time to start designing and creating new sources.

In 2015-2017, in FLNP various variants of sources that meet the above criteria were considered. In this booklet, we present a proposal of a pulsed neutron source of the fourth generation on the basis of a linear proton accelerator and Np-237 subcritical multiplying system with mechanical modulation of reactivity (superbooster).



V.L.Aksenov



E.P.Shabalin

May, 2018, Dubna

# Scientific opportunities



## Scientific opportunities

Neutrons are used for studying fundamental symmetries and interactions, structure and properties of nuclei, but nowadays neutrons are mostly required in investigations of condensed matter including solid states, liquids, biological systems, polymers, colloids, chemical reactions, engineering systems, etc. What mainly underpins our present-day quality of life depends upon our understanding and control of the behavior of materials. The neutron in many ways is an ideal probe for investigating materials, having significant advantages over other forms of radiation in the study of microscopic structure and dynamics.

Nobody can predict scientific challenges 20-30 years ahead. We can, however, extrapolate from the present and foresee where major advances might be possible.

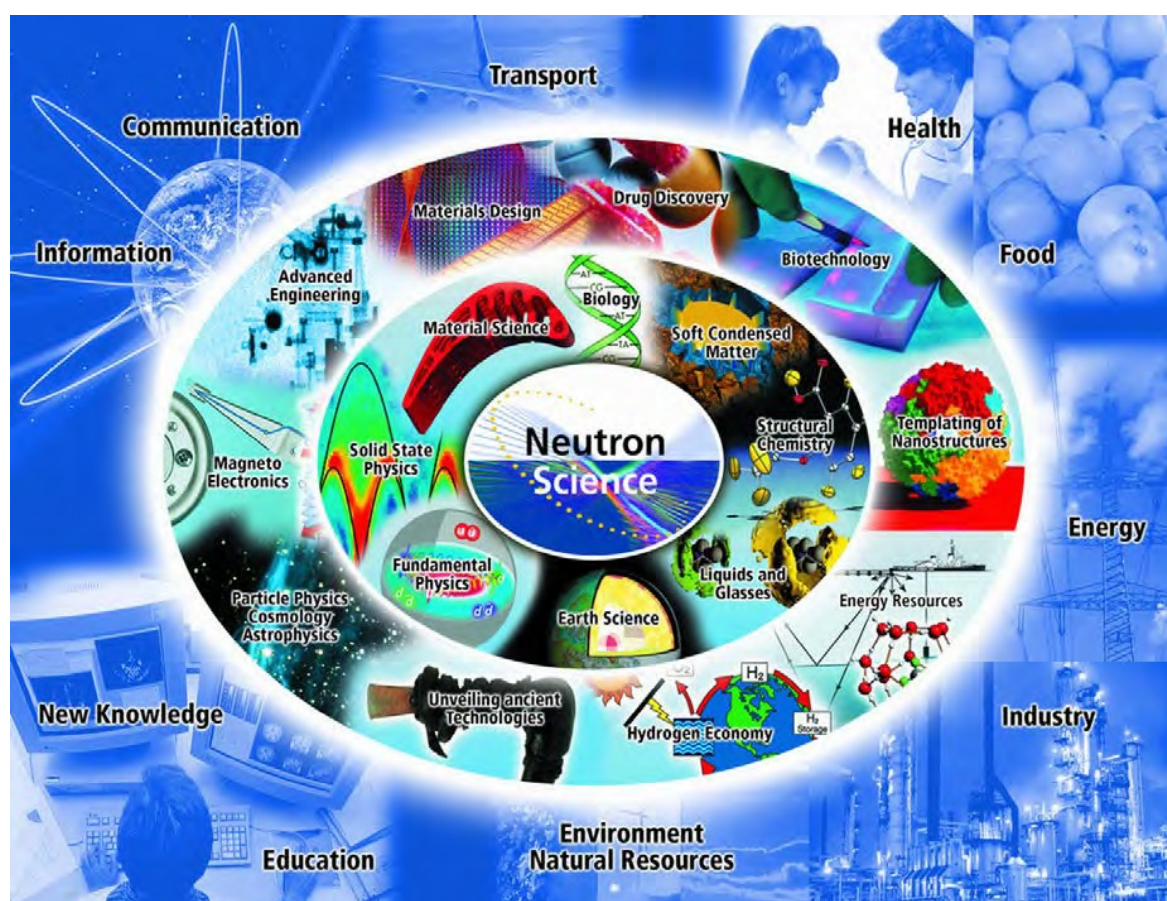

This figure presents a general scheme of participation of neutron investigations in the process of interaction of science with various branches of economy. This scheme is, of course, idealized and suggests that science nourishes technologies with its discoveries, and economy poses challenges to science. In reality, science develops according to its own laws and

problems arise naturally with the development of the experimental base, and our understanding of the laws of Nature. Nevertheless, this scheme should be taken into consideration in the organization of activity of large research centers on the basis of mega-facilities.

Below, we consider some scientific problems, for the solution of which we need advanced neutron sources with the above stated (in the Preface) parameters (for more details see V.L.Aksenov, JINR Communications, E3-2017-12, Dubna, 2017).

**Condensed Matter Research.** Nowadays, more than 90% of extracted neutron beams are used for condensed matter research related to a wide variety of scientific fields such as solid state physics, soft matter (complex liquids, non-crystalline solids, polymers), chemistry, molecular biology, materials sciences, and engineering sciences. New fields of research are constantly emerging. For example, one can mention the recently growing interest in the structure and properties of food and objects of cultural heritage. Over the past years, a number of new problems have appeared in all mentioned sciences where neutron scattering can provide very useful information on the structure and dynamics. Practically every new phenomenon and new material (especially in solid state physics) is probed by neutrons at an early stage of research. For example, a lot of possibilities are opening in the use of isotope substitution as illustrated in the figure.

Slow neutrons ( $\lambda = 0.1 - 4 \text{ nm}$ ) are an ideal technique for nanodiagnosics of hydrogen-containing systems

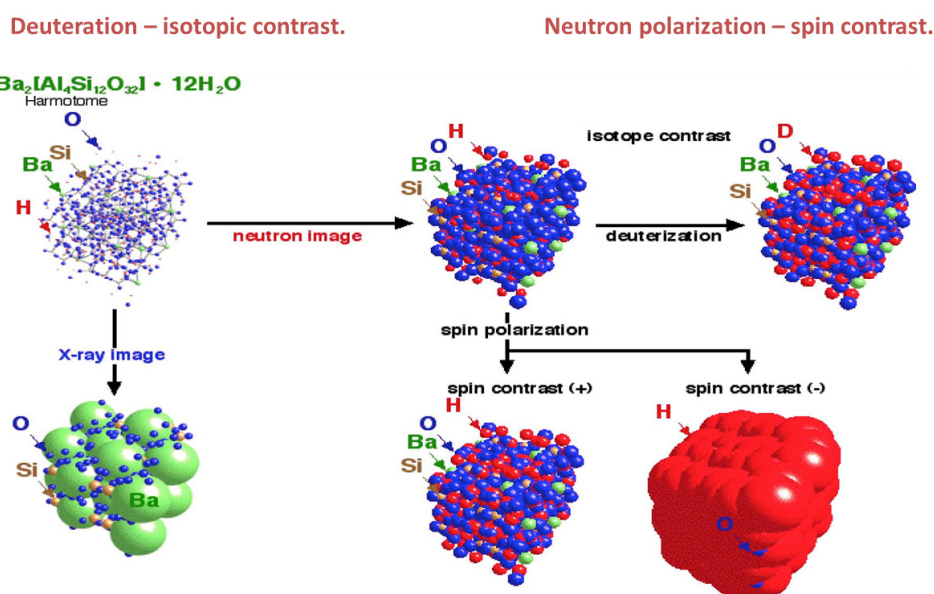

A special role in the study of condensed matter is played by polarized neutrons, which provide much more detailed information about the structure of matter not only in inorganic magnetic materials (as can be seen from the schematic drawing) but also in biological objects. In this case, the use of polarized neutrons makes it possible to enhance the contrast of the structure image, which is an important complementary technique to the widely used isotopic contrast method. The figure shows the difference in the small-angle neutron scattering spectra in magnetic colloids using polarized and non-polarized neutrons.

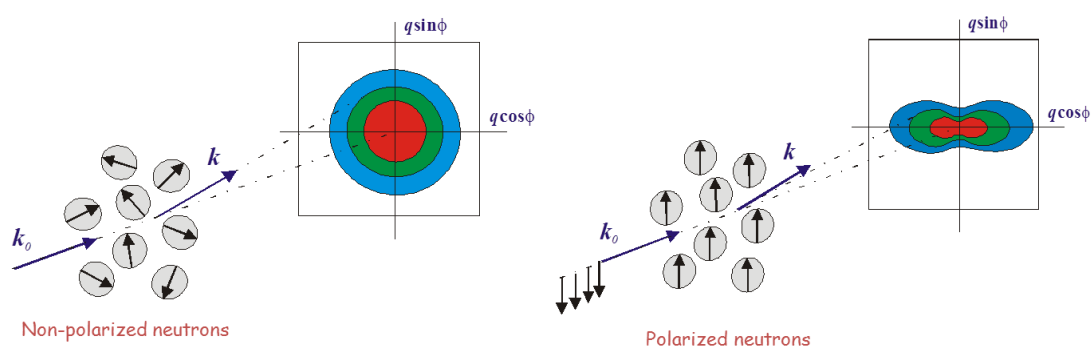

Condensed matter being a system with an infinite number of degrees of freedom similar to the particle world is a permanent source of new phenomena. From this point of view, the main strategy of any user research center based on a large facility consists in the development and construction of advanced experimental techniques and instruments to be ready for new challenges and to attract more scientists from different research centers with original proposals. The construction of a new-type neutron source in Dubna in 1960 led to the appearance of a lot of new experimental techniques. Time-of-flight (TOF) neutron diffractometry was born in Dubna in 1963. Later, this method was developed in a number of neutron centers including FLNP. For example, the High Resolution Fourier Diffractometer (HRFD) and Real Time Diffractometer (RTD) at the IBR-2 reactor provide realization of such advanced methods. Both of them will have much more possibilities at a neutron source that will be more intense than the IBR-2 reactor. A very important method, inelastic neutron scattering, is very difficult for implementation at IBR-2. Investigations of atomic and molecular dynamics are an important tool for neutron scattering, and for full-scale experiments a neutron flux of one order higher than that at IBR-2 is crucial. Nowadays, small-angle scattering and reflectometry are becoming more and more popular. FLNP is among the leaders in the realization of these methods.



At the IBR-2 reactor, the user program is organized in full accordance with the generally accepted rules of the Institute.

There are two calls for proposals per year with deadlines on April 15 and October 15. Applications are collected via web-site <http://ibr-2.jinr.ru>

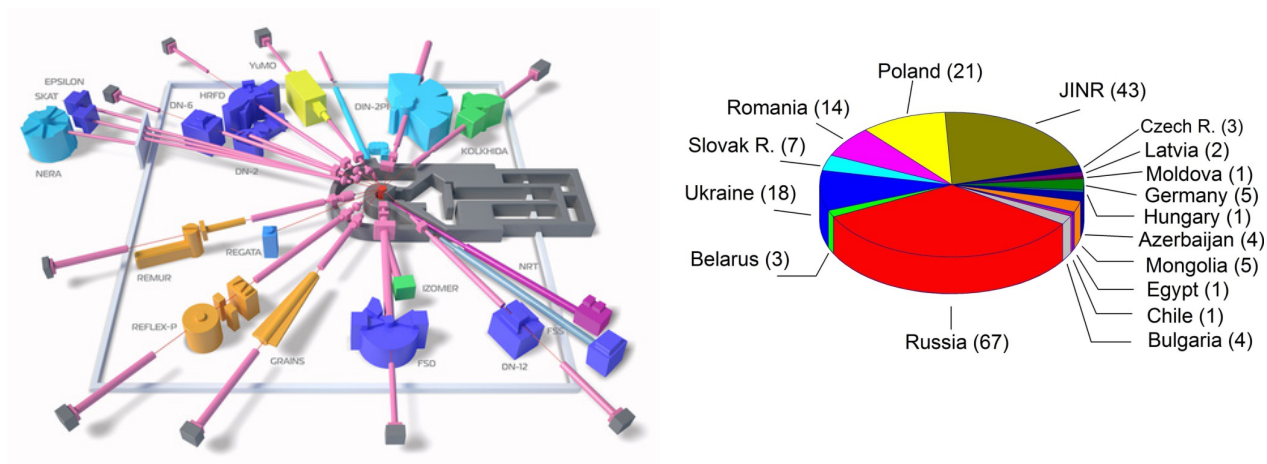

*More than 200 applications from 18 countries were received in 2017.*

A more intense neutron source will be a source of new scientific opportunities. Some of them are listed below. **In solid state physics:** nanocrystals, low-dimensional systems, magnetism and superconductivity. **In chemistry:** *in situ* real-time measurements for synthesis of novel materials. **In Earth and environmental sciences:** structural studies of complex minerals at high temperatures and high pressures for improving the understanding of basic geological processes. **In engineering sciences:** nondestructive control of engineering products and machine components to improve industrial technologies. **In soft matter research:** structural and real-time studies of polymers, colloids, liquid crystals, nanoliquids for a lot of industrial processes. **Biology and biotechnology:** structural studies of macromolecular complexes, kinetic measurements of DNA synthesis, drug delivery, etc.

During the last decades the focus of modern research has shifted towards the study of soft matter with attempts to investigate living matter. Living matter is the most complicated and interesting subject for the modern science. In fact, this field of research is at the limits and in some cases even beyond the possibilities of present-day physics. Living systems have a number of specific features. They have long-living, slowly-relaxing structures which are far from equilibrium. The next important property is the irreversibility of many processes. We can explore

some features of living matter such as kinetics, structure hierarchy, self-assembly by studying soft matter. From our point of view, one of the main directions of the research programme for a new neutron source could be related to the study of soft and living matter and key problems of biophysics with application in biomedicine and pharmacology, which is in line with the modern trends in the world science. In this respect, we need the advanced development of all experimental techniques which are available now.

### Current challenge: from soft matter to life matter

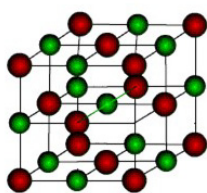

#### Solid Matter

Crystalline Solids  
Amorphous Solids  
Quasicrystals  
Low Dimension  
Structures

- fluctuations
- relaxation

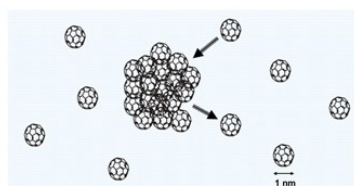

#### Soft Matter

Neither simple liquids  
nor crystalline solid

- length scale intermediate  
between atomic size and  
macroscopic scales
- kinetics, self-assembly
- hierarchy



#### Life Matter

Nuclear Acids (DNA, RNA)  
Proteins, Polysaccharides,  
Membranes

- long-living, slowly-relaxing  
structures
- self-organization
- irreversibility

In the 21st century, bioscience will become one of the most rapidly developing areas of research, providing solutions to major challenges facing humankind. Today, we have considerable progress in deciphering the nature and the origin of problems concerning human health. One of the most important approaches is to make use of techniques that allow scientists to “see” the structure and dynamics of biologically significant materials at the atomic and molecular scale in the ideal case under conditions as close to physiological as possible. There are several complementary methods – X-ray and neutron scattering, nuclear magnetic resonance (NMR) and electron microscopy which are used together to determine the shape and internal structure of bioactive molecules such as proteins, as well as to understand the mechanisms of their functioning. By using X-ray crystallography, one can determine the positions of atoms in very small crystals containing large numbers of identical proteins. NMR methods allow one to

obtain three-dimensional structures of proteins in solutions or in the solid environment. Also, cryoelectron microscopy provides images of the overall shape of large complexes of biological molecules due to the possibility of measurements in water, the natural media for living objects.

Neutrons, like X-rays, reveal a microscopic structure through the scattering from the ensembles of atoms in a sample. Neutron beams are much less intense than X-ray beams produced at large-scale facilities, and neutron crystallography requires larger samples than in analogous X-ray experiments. Nevertheless, neutron methods play a unique role in life and health sciences, due to the possibility of measurements in water, the natural media for life objects.

**Nuclear Physics.** Since its emergence, neutron nuclear physics has demonstrated its effectiveness, becoming the basis of nuclear power engineering and a tool for studying the nuclear structure and properties of fundamental interactions. The tasks that this area of research faced in the early 21st century (V.L.Aksenov, *Particles and Nuclei* 31 (6), p. 1303 (2000)) are still of particular importance. They echo the questions that were formulated by the international scientific community when discussing the prospects for the development of nuclear physics (NuPECC, Long Range Plan 2017). High-precision determination of neutron properties, parameters of its decay and neutron cross sections, studies of neutron-induced fission and nuclear reactions with neutrons are valuable and sometimes unique sources of information for solving cosmology problems, studying the properties of the Universe at an early stage of its formation, properties of nuclear matter and fundamental interactions. Nuclear neutron methods (such as activation analysis) have found wide application as a powerful analytical method in environmental, biological research and archeology. These methods are widely known to be used to study the surface of planets of the Solar System. The application of these methods in a number of industries holds much promise. The study of cross sections for interactions of neutrons with nuclei for the needs of nuclear power engineering is still of considerable significance.

Nuclei are collections of protons and neutrons. This can be plotted on a kind of nuclear landscape with a long valley of stability. On either side of the valley of stability are areas inhabited by unstable nuclei with an increasing number of protons and neutrons. These areas are bounded by the so-called driplines. It is known where the proton dripline is, but only the lower part of the neutron dripline has been investigated so far. Studies of extreme nuclei provide stringent tests for nuclear models and also for the theories of underlying nuclear forces. Nuclei

with high proton-to-neutron ratios can be obtained relatively straightforwardly with the help of accelerators. The obtaining of neutron-rich nuclei is more difficult, and only few facilities worldwide can produce their reasonable amounts.

## Understanding the nucleus

Probing exotic (n-rich) nucleus

Nuclear Structure (nuclear models)  
Phase Transitions in nuclei

Fission Physics  
Nuclear Data

Astrophysics (where do the heavy elements come from?)

Superheavy elements  
Stability Island

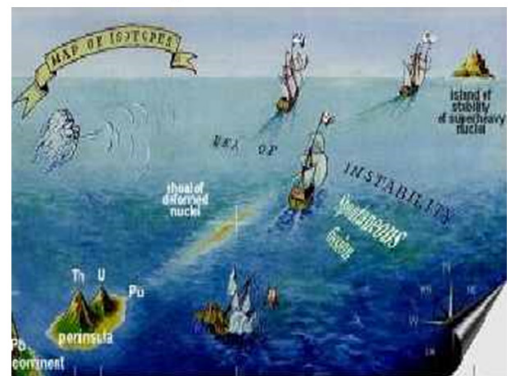
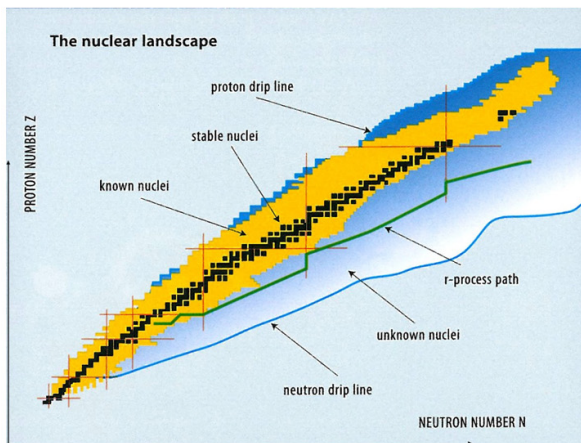

2016:

- 113 - Nihonium (Nh),
- 115 - Moscovium (Mc),
- 117 - Tennessine (Ts),
- 118 - Oganesson (Og)



Neutron-rich nuclei located close to the r-process path can be created by nuclear fission. The fission itself is also a rich source of information: the abundances of fission fragments produced and their excited states depend on the nuclear structure. A high-flux neutron source can provide very exotic neutron-rich nuclides with very high production yields. The pathway of the r-process can be determined by mass measurements for a set of these nuclides.

**Basic Research.** The discovery of the Higgs boson opens up a new era in physics. The established theory describing weak, strong and electromagnetic interactions of all known particles is the Standard Model (SM) of particle physics. However, it does not seem to be a complete theory. What is new physics beyond SM? In this respect, precision experiments with low-energy neutrons can provide a great deal of new information. For example, the discovery of neutron-antineutron ( $n\bar{n}$ ) oscillations could answer crucial questions of particle physics and cosmology. Why do we observe more matter than antimatter in the Universe? Another related

intriguing subject potentially accessible with this process concerns the mechanism responsible for neutrino mass generation. A high neutron flux combined with the progress made in neutron optics offers a remarkable opportunity to perform a sensitive experiment dedicated to search for such oscillations. The next flagship experiment could be a direct measurement of neutron-neutron cross section.

## Neutrons and New Physics

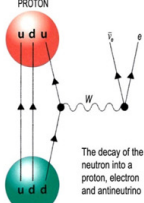
<p>Early Universe : <math>\tau_n</math></p> <p>Barion asymmetry : EDM</p> <p>Left-right symmetry : <math>(n, a)</math></p>	 <p style="font-size: small;">The decay of the neutron into a proton, electron and antineutrino</p>	<p>Dark energy } UCN gravity resonance</p> <p>Dark matter } Spectroscopy in ILL</p> <p style="color: red; text-align: center;"><b>Neutrino Physics</b></p> <p style="text-align: center;"><b>F.L.Shapiro</b></p>
--	--	--

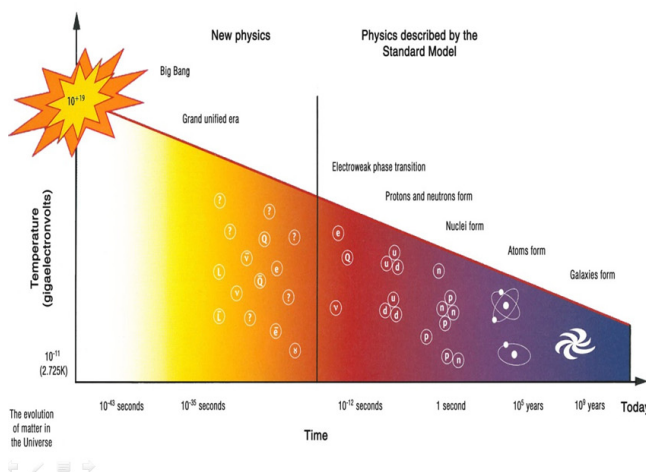

6.04.1915 - 30.01.1973

Very intriguing perspectives are arising in experiments on the problem of quantum measurements.

An extensive field of research is opened up with the use of UCN. Traditional attempts are related to new physics beyond the SM through measurements of neutron lifetime  $\tau_n$  and electric dipole moment (EDM). However, it seems that recent observations of UCN quantum states in a gravitational field have much prospect. Indeed, it is a new research field including the investigation of dark matter and dark energy and especially precise measurements of structure and dynamics of surfaces at the nanoscale.

UCN physics is traditional for FLNP. Remember that UCN were discovered by F.L.Shapiro's group in 1968. FLNP scientists take part in all leading experiments with UCN and have a number of new ideas for a new more intense neutron source.

**Flagship experiments.** A number of research areas mentioned above have a relatively long history and impose high requirements for the parameters of the neutron source, primarily for the high neutron intensity. The increase in intensity makes it possible not only to improve the rate of statistics collection, but also to study systematic effects at a new level, which is an important factor for high-precision experiments. New prospects for increasing the accuracy of experiments are also associated with the possibility of creating high-intensity sources of ultracold neutrons and very cold neutrons on the new neutron source. In combination with the pulsed mode of operation of the source, this opens up new methodological possibilities, for example, for measuring the neutron lifetime. At the stage of developing the source, a number of design solutions can be built in, which will allow measurements to be carried out in the optimal geometry (neutron-neutron scattering, neutron-antineutron oscillations) and during the construction of the source the necessary infrastructure can be prepared (for example, devices for polarization of nuclear targets and neutrons).

In conclusion, we will formulate in a short form scientific opportunities with the NEPTUN superbooster.

### ***Investigations***

**Structure and dynamics of soft and biological systems with high flux and polarized neutrons**

**Crystal and magnetic structure with high resolution and real-time diffraction at high pressure and magnetic fields**

**Neutron-antineutron oscillations**

**Dark matter and dark energy with UCN**

**New Quantum phenomena with neutrons**

**Neutron-rich nuclei at isotope separator on-line system with neutrons, fission**

**Irradiation, isotopes**

### ***Expected results***

**Primary and tertiary structures  
Intramolecular dynamics  
Bioenergetics of a cell  
Biomedicine and pharmacology**

**New functional materials**

**Beyond the Standard Model**

**New Physics**

**New aspects of quantum mechanics and consciousness**

**Nuclear "Standard Model"**

**Radiobiology, medicine**

# World neutron landscape

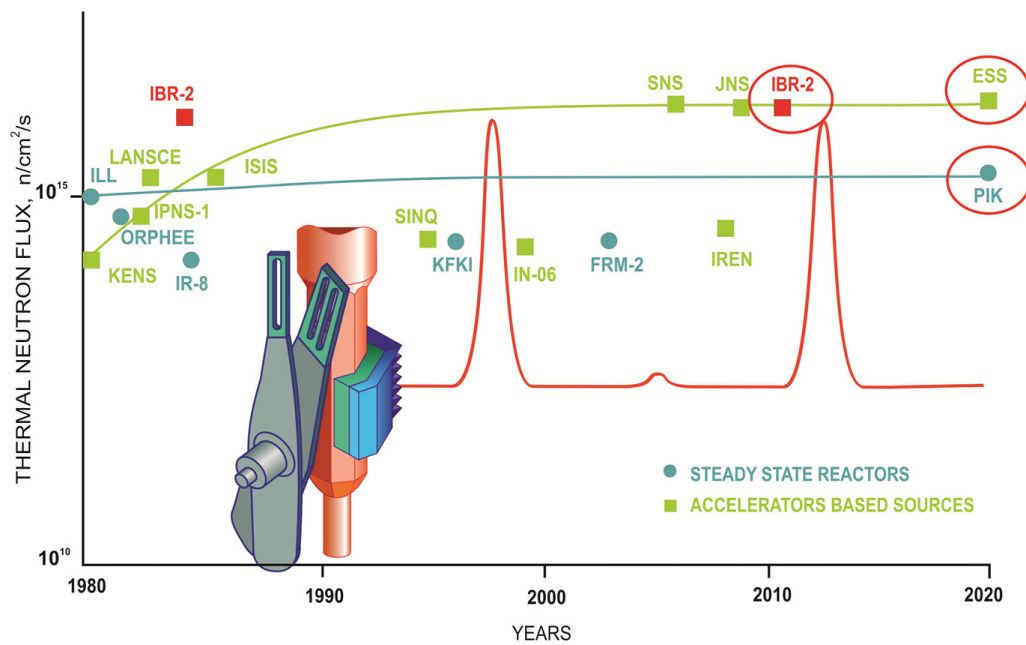

World neutron landscape

The following two schematic figures (after Th. Brückel from Jülich Forschungszentrum) illustrate the changing European landscape of neutron sources.

**European Largest Neutron Centers 2018**

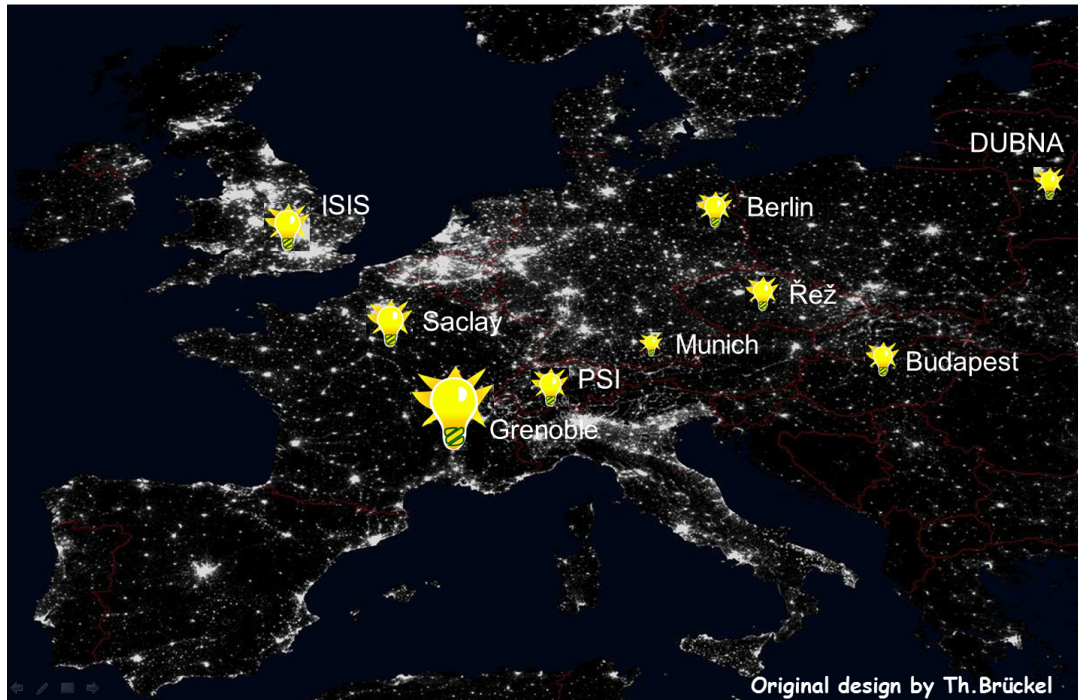

**Possible Neutron Scenario for Europe after 2032**

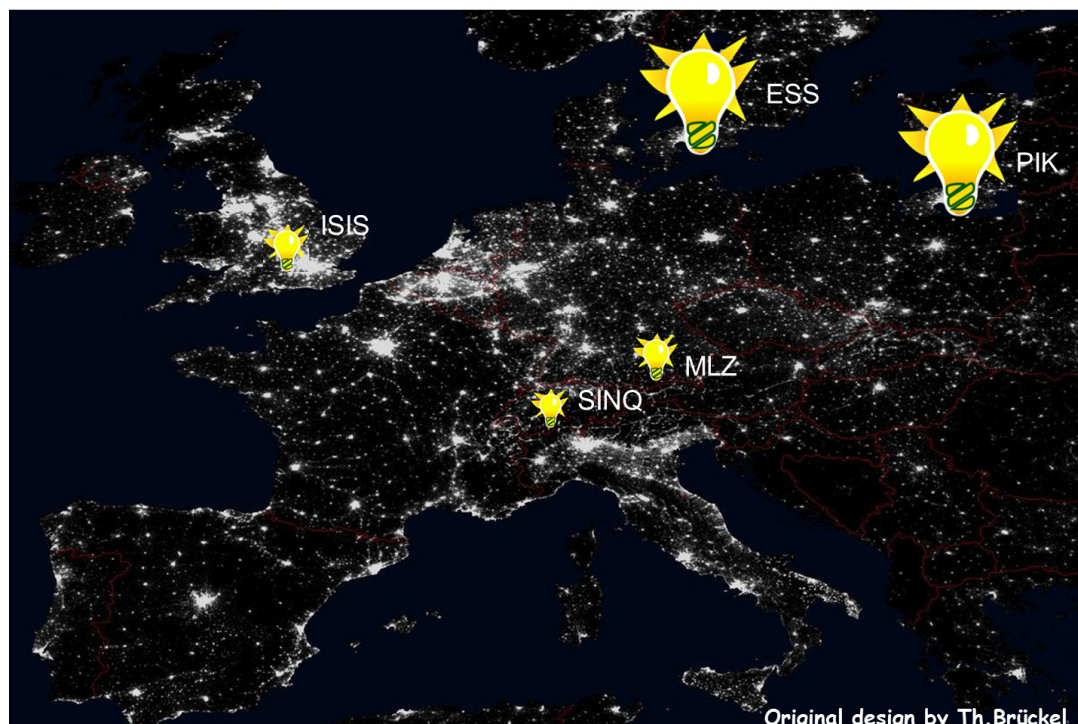



In Europe, there are only ten leading neutron centers with a developed user systems.

Source	Commissioned, year	Thermal energy, MW	Average neutron flux, $\text{cm}^{-1}\text{s}^{-1}$	Peak neutron flux, $\text{cm}^{-1}\text{s}^{-1}$	Number of operating days per year	Number of stations	Possible number of stations	Number of users per year	Operating costs, $10^6$ euros
<b>FRM II</b> , Münich	2005	20	$8 \times 10^{14}$		240	23 in operation, 7 under construction	35	1000	55
<b>BER II</b> , Berlin	1991	10	$1.2 \times 10^{14}$		220	16 in operation	20	400	25
<b>ILL</b> , Grenoble	1975/1995	58	$1.3 \times 10^{15}$		200	27 + 10 CRG*	>40	1400	80 + CRG
<b>ESS</b> , Lund	2019, planned	5, LP		$4 \times 10^{16}$	200	20 after 2025	>20		103
<b>PIK</b> , Gatchina	2019, planned	100	$5 \times 10^{15}$		200	22 after 2022	>40		30
<b>LLB</b> , Saclay	1985	14	$3 \times 10^{14}$		200	22	25	600	25
<b>SINQ</b> , Villigen	1996	1	$1.5 \times 10^{14}$		200	15	20	600	30
<b>ISIS/ ISIS-II</b> , Abingdon	1985/2009	0,2, SP		$4.5 \times 10^{15}$	180	34	41	1500	55
<b>IBR-2</b> , Dubna	1984/2012	2, LP		$6 \times 10^{15}$	108	14	14	200	1
<b>WWR</b> , Budapest	1959/1993	10	$2.1 \times 10^{14}$		140	14	14	100	10

\*CRG – abbr. for Collaborative Research Group instruments.

#### *Leading user centers in Europe (after ENSA report).*

Considering the present-day tendency, after 2030 only five sources will be available including three currently operating facilities: ISIS (Didcot, UK), SINQ (PSI, Villigen, Switzerland), FRM II (TU Munich, FRG), and two new sources (ESS (Lund, Sweden) and steady-state reactor PIK in the Petersburg Nuclear Physics Institute of the National Research Center “Kurchatov Institute” (Russia)) which are under construction at the moment. Over the last years this situation has sparked lively discussions on new neutron sources in Europe. A medium-power source (which is much cheaper compared to ESS) on the basis of a deuteron linear accelerator with a Be target has recently been proposed to be constructed at the Jülich Research Center. Similar sources for Saclay and Bilbao are under consideration.

The Table below (see V.L.Aksenov, A.M.Balagurov, *Physics – Uspekhi*, v. 59 (3), 2016) shows only the world's leading pulsed sources as reference points.

## World neutron landscape

Country, city	Name, start of operation/ refurbishment	Target power, MW	Peak neutron flux, $10^{14} \text{ cm}^{-2}\text{s}^{-1}$	Thermal neutron pulse duration, $\mu\text{s}$ ; frequency, $\text{s}^{-1}$	Time-averaged neutron flux, $10^{12} \text{ cm}^{-2}\text{s}^{-1}$	Number of beams/cold moderators	Experimental stations				
							Diffraction	Small angle	Reflectometer	Inelastic	Other
<b>England</b> Chilton	ISIS I, 1985	0,2	10	20÷30; 50	1,5	16/ 2	10	2	3	7	1
	ISIS II, 2009		45	20÷30; 5	0,7	13/ 1	6	4	5	2	2
<b>USA</b> Los-Alamos Oak-Ridge	MLNSC, 1985	0,1	7	20÷30; 20	0,4 4	16/ 2 14/ 1	4	2	3	2	2
	SNA, 2006 STS, project	1 0,5	12 50	20÷50; 60 50÷200; 10	10		7	2	3	7	3
<b>Japan</b> Ibaraki	JSNS, 2009, plan	1	20/ 65	20÷50; 25	10/ 30	21/ 1	7	1	2	3	7
<b>China</b> Donguan	CSNS 2018, plan	0,1	~5	20÷50; 25	~1	20					
<b>Russia</b> Dubna	IBR-2, 1984/2012	2	60	310; 5	10	14/ 2	6	1	3	2	2
<b>Sweden</b> Lund	ESS 2019, plan	5	50÷75	2800; 14	200÷300	16/ 1 first phase	5	2	2	6	1

### *World's leading pulsed sources.*

The need for a next-generation neutron source is driven by a growing interest in these investigations against the background of a steadily decreasing number of neutron sources in the world, as evidenced by the analysis of a specially established ESFRI Physical Sciences and Engineering Strategy Working Group (ESFPI Scripta, Univ. Milano, 2016).

To balance the world neutron landscape, one more intense pulse neutron source of the fourth generation is needed in Russia. For the advanced research programme outlined in the previous Sec., we need the following parameters for the neutron flux density: peak  $\overline{\Phi} > 10^{16} \text{ cm}^{-2}\cdot\text{s}^{-1}$  and time-averaged  $\overline{\Phi} > 10^{14} \text{ cm}^{-2}\cdot\text{s}^{-1}$ .

The pulsed neutron sources discussed above are used mainly for neutron scattering as we can see in the Table. Remember that neutron sources for beam research can be either steady-state (mostly reactors) or pulsed (mostly accelerators). The latter sources vary in pulse width:  $\Delta t < 10 \mu\text{s}$ , (very short pulse),  $10 < \Delta t < 50 \mu\text{s}$  (short pulse),  $\Delta t > 100 \mu\text{s}$  (long pulse). For traditional neutron spectroscopy in nuclear physics where resonance neutrons are used, for the

most part, very short pulses are needed. For neutron spectroscopy in condensed matter where thermal neutrons are used predominantly, short pulses are required. The successful experience of the IBR-2 reactor operation ( $\Delta t = 320 \mu\text{s}$ ) has drawn the attention of neutron society to long-pulse sources (LPS). ESS, for example, will have  $\Delta t = 2800 \mu\text{s}$ . The main advantage of LPS is high neutron flux and, as a result, the possibility to perform not only scattering experiments on condensed matter but also experiments on fundamental physics and nuclear physics. We can conclude that a new neutron source will be particularly high in demand being a long-pulse source. For JINR with its IBR-2 experience a long-pulse source would be suitable. It would also be highly preferable to have a short-pulse option. In this case, all possibilities of neutrons can be used.

Neutron source (laboratory)	$\langle I_n \rangle$ , $10^{15} \text{ n/s}$	$\Delta t$ , ns	$Q$ , $10^{30} \text{ n/s}^3$	Number of instruments for nuclear physics experiments
LANSCE (LANL, USA)	10	1-125	0.64*	8 (total, partial cross sections) +ICE House test facility
n_TOF (CERN, Switzerland)	0.4	10	4	6 (total, capture, fission, scattering, (n, $\alpha$ ))
ORELA (ORNL, USA)	0.13	2-30	0.14*	5 (total, partial cross sections)
GELENA (IRMM, Belgium)	0.025	1	25	5 (total, partial cross sections)
GNEIS (PNPI, Gatchina)	.3	10	3	3 (total, capture, fission) + ISNP/GNEIS test facility
IREN (JINR, Dubna, project)	1.0	400	0.0062	under construction

$\langle I_n \rangle$  – average intensity of neutrons emitted in  $4\pi$  solid angle;

$\Delta t$  – neutron pulse width;

$Q = \langle I_n \rangle / (\Delta t)^2$  – quality coefficient of neutron source;

\* – present value corresponding to the maximum pulse width.

*Very short pulsed neutron sources for nuclear physics.*

The problem of neutron sources is particularly acute in Russia. The diagram shows the neutron sources that can be used for research on extracted beams. At present, only the IBR-2 reactor is used in the format of international standards. After the IBR-2 reactor is put out of service, there will remain only one research reactor in Russia – reactor PIK in NRC “Kurchatov Institute” (Gatchina). Other sources will be decommissioned due to the expiration of their expected service life.

## User Neutron Sources in Russia

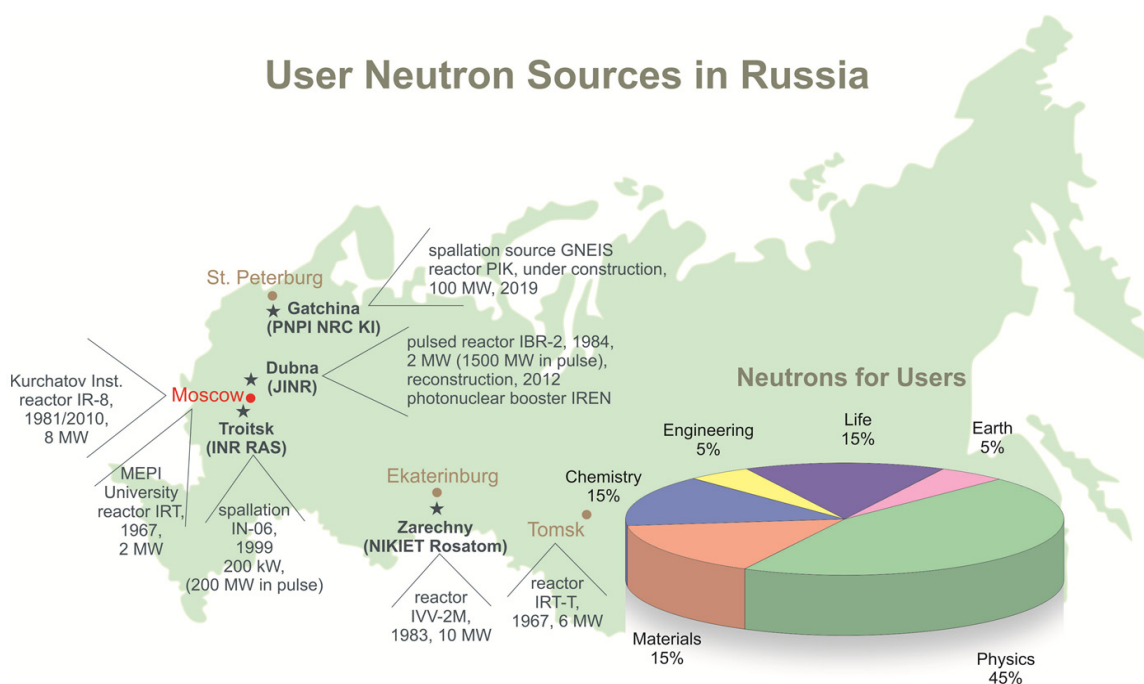

Device	Organization	Commissioned, year	Power, MW	Neutron flux, $10^{14} \text{ cm}^{-2}\text{s}^{-1}$	Number of stations
IR-8	NRC KI, Moscow	1957/1981/2012	2/5/8	1	4 + 5
WWR-M reactor	PNPI NRC KI, Gatchina	1959/1978 Prolonged shutdown since 2016	5/18	4.5	12
WWR-Ts reactor	Branch of RIPC, Obninsk	1964	13	1	3
IWW-2M reactor	IRM, Zarechnyi	1966/1983	15	2	5
IRT-T reactor	RI TPI, Tomsk	1967/1977	6	1.2	–
IPT reactor	NRU MEPhI, Moscow	1967/1975 Prolonged shutdown since 2013	2.5	0.3	4
GNEIS (pulsed) $\Delta t_0 = 10 \text{ ns}$	PNPI NRC KI, Gatchina	1973/1983	$3 \times 10^{-3}$	1	3
IN-06 sources (pulsed) $\Delta t_0 = 100 - 200 \mu\text{s}$	INR RAS, Troitsk	1999	$3 \times 10^{-1}$	1	7 + 2
IREN (pulsed) $\Delta t_0 = 30 \text{ ns}$	JINR, Dubna	2010	$4 \times 10^{-3}$	0.1	3
PIK reactor	PNPI NRC KI, Gatchina	2019, planned	100	45	22 after 2022

### *Characteristics of neutron sources in Russia for studies with extracted beams.*

A new intense neutron source of the fourth generation is required on the territory of Russia. This source will be complementary to the PIK reactor as these two sources will give the possibility to use the whole spectra of neutron scattering methods in traditional fields of research as well as in new ones such as living matter research. It is especially important for nuclear physics, the scientific basis for nuclear power engineering. And Dubna is the most appropriate place due to the long-term development of neutron research here.

# Why a superbooster

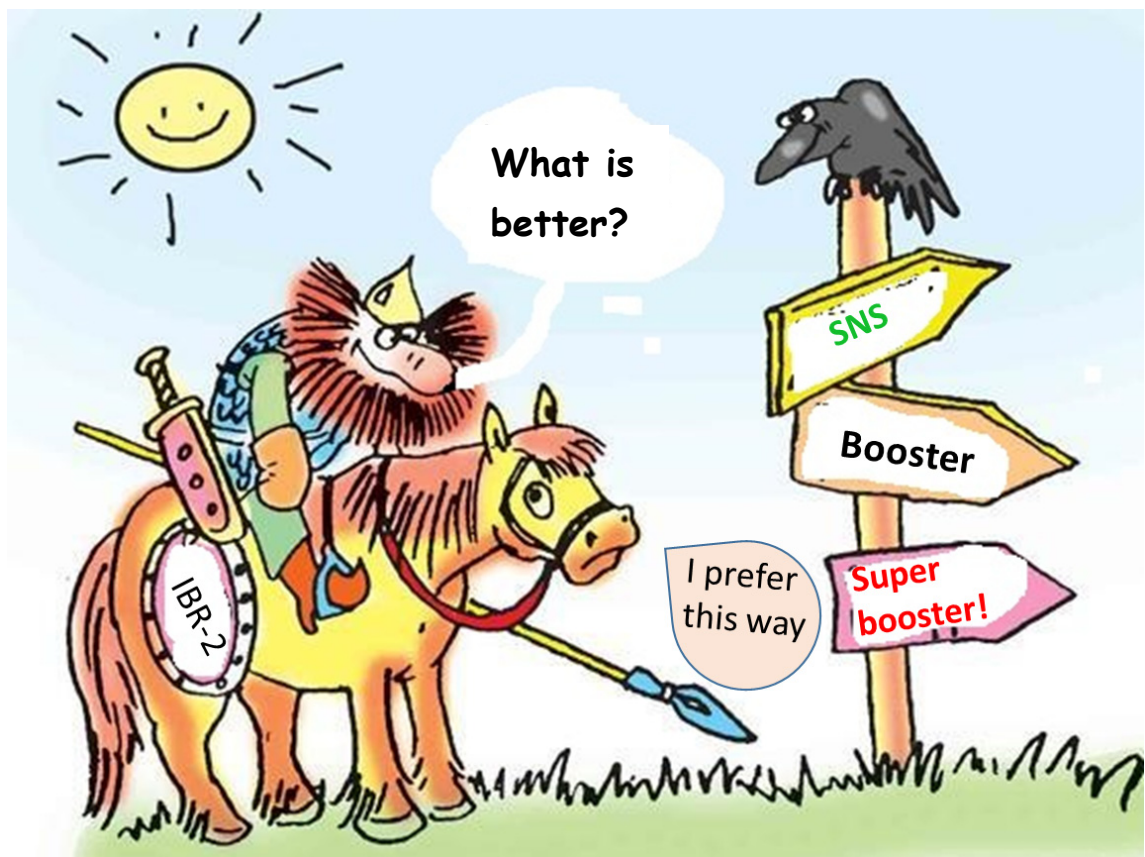

At present, the highest neutron flux is produced on sources of three types. The figure below shows the evolution of neutron sources.

1. Continuous flux reactors: HFR (ILL) at present and PIK reactor (NRC “Kurchatov Institute” – PNPI) in the future.
2. Spallation neutron sources: SNS (Oak Ridge) at present and ESS (Lund) in the future.
3. Pulsed reactors of periodic operation: IBR-2.

## ADVANCED NEUTRON SOURCES

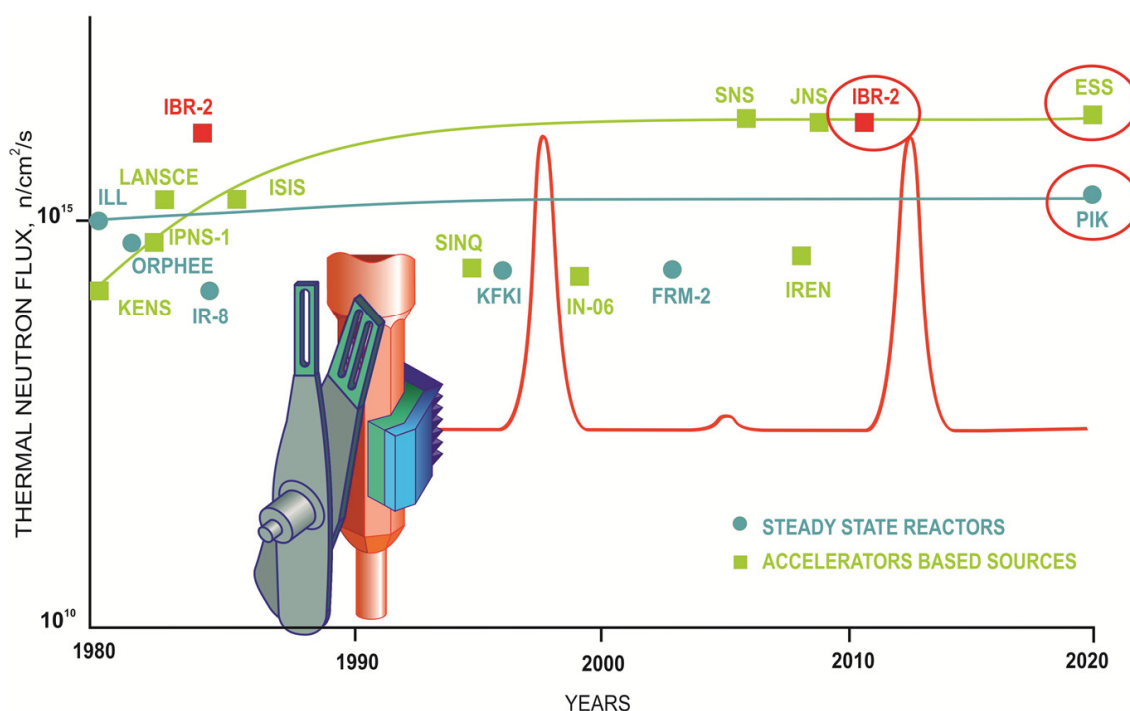

All three types of sources have reached their technological limits. Therefore, to achieve higher neutron fluxes, new solutions must be sought. We propose to develop the fourth type of neutron sources – a superbooster (E.P.Shabalín, V.L.Aksenov, G.G.Komyshev, A.D.Rogov, Atomic Energy, 2018, in print).

**Superbooster is an accelerator driven multiplying neutron-producing target with periodic modulation of reactivity. Reactivity modulation allows working with a high neutron multiplication factor of a source.**

Using a superbooster mode, with an accelerator even of relatively small beam power of 50-100 kW, it is possible to obtain pulsed neutron flux densities in extracted beams, which would be upper limits for nuclear facilities and unattainable for modern accelerator-based neutron sources (V.L.Aksenov, V.D.Ananiev, G.G.Komyshchev, A.D.Rogov, E.P.Shabalin, Phys. Particles and Nuclei Letter, v. 14, N 5, 2017).

The advantages of a superbooster over other intense pulsed neutron sources (pulsed reactor of periodic operation, spallation source (proton accelerator plus heavy metal target without fission) and booster (accelerator plus multiplying target)) are determined by the following. The efficiency of a pulsed neutron source depends on the peak neutron flux density,  $\hat{\Phi}_n$ , and neutron pulse duration,  $\Delta t$ . The time-averaged neutron flux duration is determined by these parameters and neutron pulse frequency,  $\nu$ . The expected reference values are  $10^{17}$  n/cm<sup>2</sup>/s for  $\hat{\Phi}_n$  and 20  $\mu$ s (short pulse) / 200 – 250  $\mu$ s (long pulse) for  $\Delta t$ . In this case,  $\nu$  is practically fixed in the narrow interval of 10 ÷ 30 Hz.

Let us look at the Table of pulsed neutron sources in the previous Section.

**Pulsed reactor** of periodic operation in principle can give  $\hat{\Phi} \leq 10^{17}$  n/cm<sup>2</sup>/s but at a thermal power of 10 ÷ 15 MW. The problem of thermal heat removal has not been solved. Besides,  $\Delta t$  cannot be less than 200  $\mu$ s and high scattering background (7÷8%) limits the experimental possibilities.

**Spallation source** at a proton accelerator with  $E_p \geq 1$  GeV is a very effective neutron source with a short neutron pulse. However, the Coulomb interaction in the proton beam restricts  $\hat{\Phi}_n$ :  $\hat{\Phi}_n \leq 10^{16}$  n/cm<sup>2</sup>/s. ESS allows increasing  $\hat{\Phi}_n$  but at  $\Delta t = 2800$   $\mu$ s.

**Booster** is able to increase  $\hat{\Phi}_n$  without increasing  $\Delta t$ . However, the increase will not be so high since the multiplication factor cannot be more than 5 – 10 at a high background of delayed neutrons.

**Superbooster** is able to increase  $\hat{\Phi}_n$  up to  $10^{17}$  n/cm<sup>2</sup>/s and even more due to a high multiplication factor (up to 500) at a short pulse and relatively low background (3%).

At the peak of the neutron pulse, the neutron multiplication factor in the core is below criticality for delayed neutrons – in other words, a superbooster operates more safely than any nuclear reactor (steady-state, pulsed, nuclear power, industrial, transport):

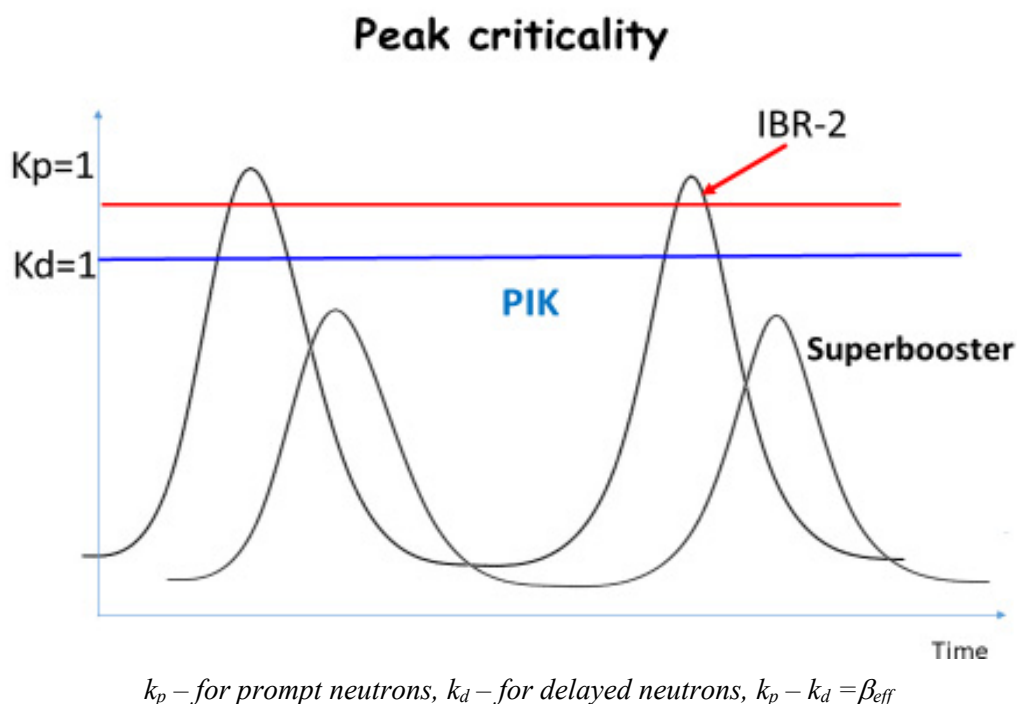

The accelerator may be with moderate parameters (energy 1.2 GeV, pulse current 50 mA, average current 0.1 mA).

The design principles of a target station with a Np-237 target are described in the next Section (E.P.Shabalin, V.L.Aksenov, G.G.Komyshchev, A.D.Rogov, Atomic Energy, 2018). A reactivity modulator makes it possible to significantly lessen the requirements for the accelerator and to obtain high neutron densities that are unachievable with a non-multiplying target.

Due to the threshold character of Np-237 fission, this source of neutrons will be more preferable than a similar plutonium-based source for several important criteria related to safety and economy.

The calculations show that one can expect the peak neutron flux density to be above  $10^{17}$  n/cm<sup>2</sup>/s and on average higher than  $10^{14}$  n/cm<sup>2</sup>/s. The thermal neutron pulse width may be  $200 \div 300$   $\mu$ s and  $20 \div 30$   $\mu$ s from different moderators.

Since 1964, FLNP neutron sources operated in a superbooster mode (see Appendix). The choice in favour of a superbooster logically follows from the history of FLNP sources.



# NEPTUN concept

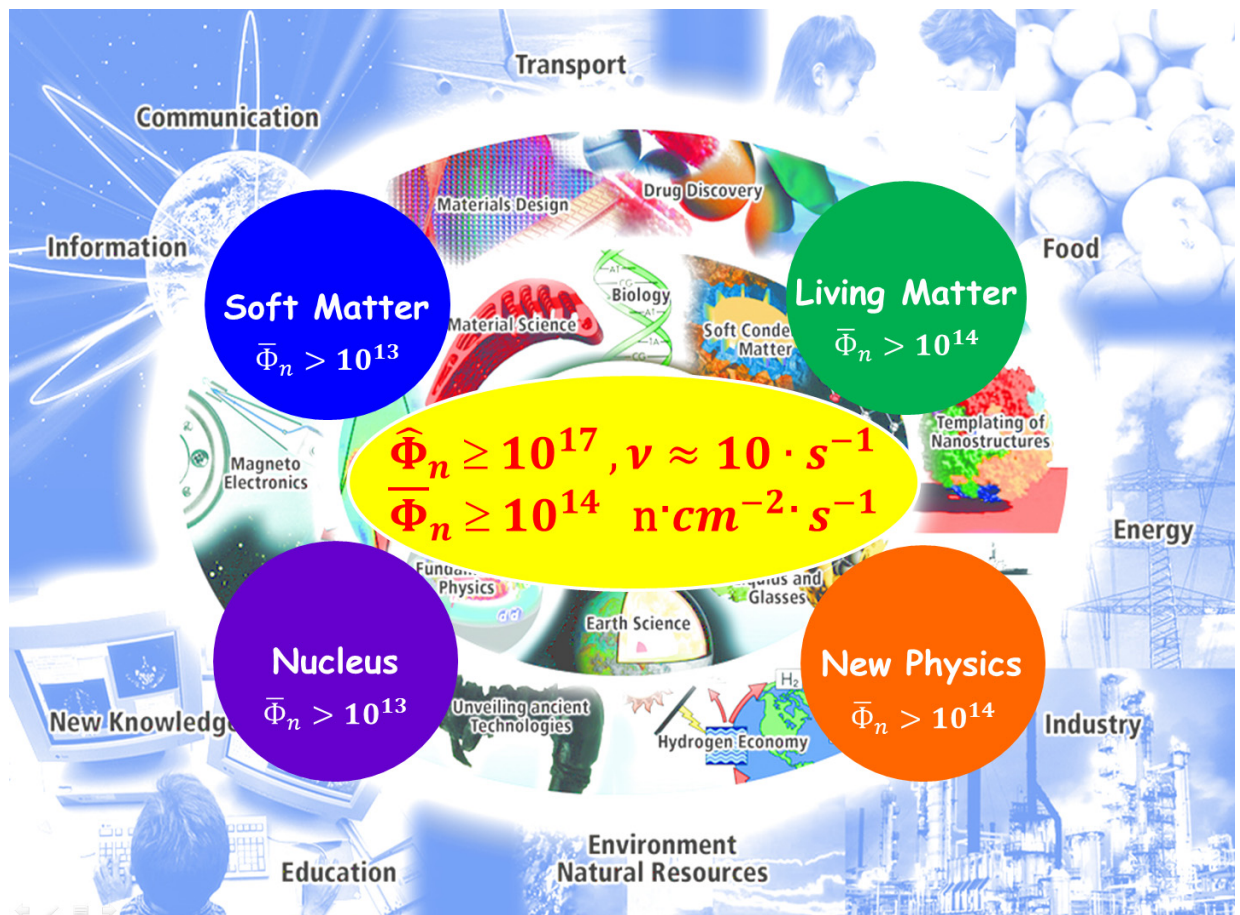

## Design principle

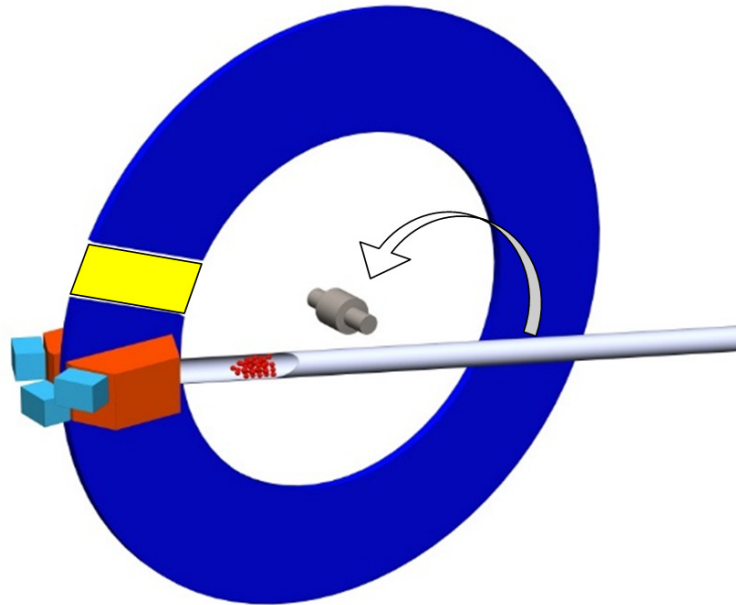
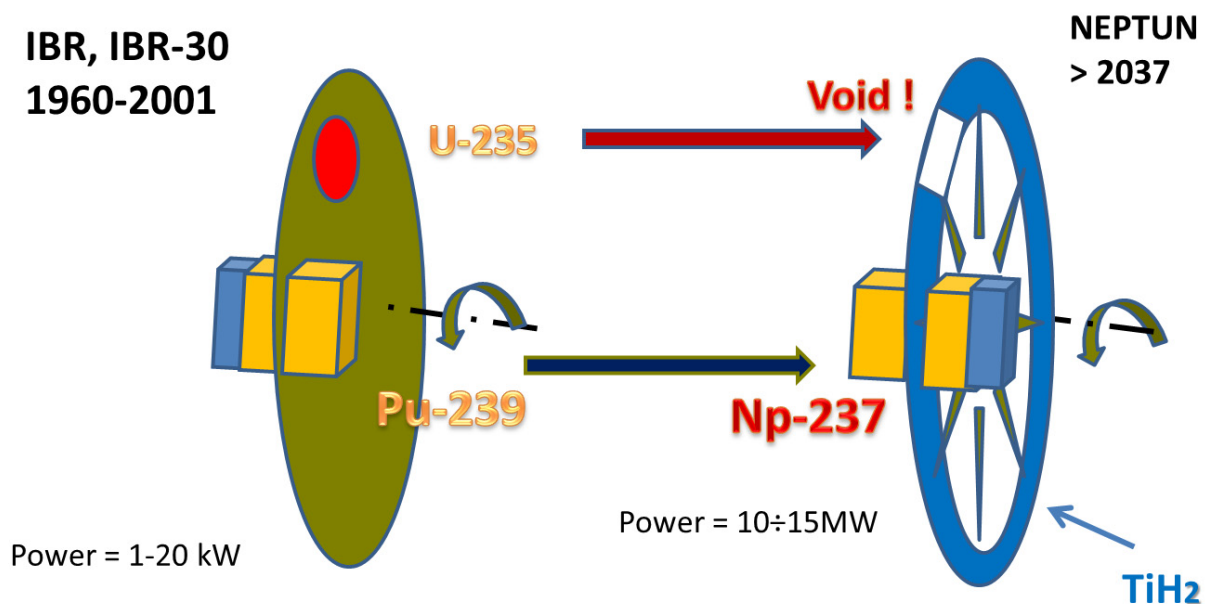

*Illustration of the superbooster design principle. The yellow sector on the modulator's disk is an empty cavity, the rest is titanium hydride. The pulses of accelerated protons (red points) are sent into the core synchronously with the passage of an empty sector through the core.*

The superbooster NEPTUN facility uses the principle of multiplication of neutrons from an external source in the core of a subcritical reactor. The function of an external source is served by neutrons created through spallation of heavy nuclei by protons with an energy of the order of 1 GeV (spallation neutrons). The linear proton accelerator operates in the regime of short proton pulses (20  $\mu$ s) or long pulses (160  $\mu$ s) at a frequency of 30 and 10 Hz. Accelerated protons are slowed down in the core, inducing cascades of neutrons with an energy from 1 to 10 MeV. The reactivity modulator modulates the neutron multiplication factor in the core with the same frequency as the proton beam repetition rate. The start of the proton acceleration cycle is controlled by the position of the active region of the modulator in the core, i.e. the multiplication of neutrons is synchronized with the proton pulse.

The NEPTUN design mainly uses the technical solutions of the IBR-2 reactor and the IBR-30 pulsed booster (liquid-metal cooling and reactivity modulator (E.P.Shabalin. Pulsed Fast and Burst Reactors, Oxford: Pergamon, 1979), but at the same time, innovations have been applied that allow reaching the upper limits of the parameters, namely:

- as a nuclear fuel, neptunium-237 is used instead of plutonium;
- modulation of reactivity is based on the principle of removal of a hydrogen-containing substance from the core;
- slow neutron beams are extracted tangentially to the boundaries of the core.



## Evolution & Continuity

Below, the effects of each of these factors are discussed in detail.

### Why Neptunium

The prospect of using neptunium in the multiplying target of a proton accelerator was first reported at the International Seminar on Pulsed Advanced Neutron Sources by scientists from FLNP JINR as early as in 1994 by E.P.Shabalin and A.D.Rogov.

Neptunium-237 in contrast to conventional nuclear fuels based on U-235 and Pu-239, has a threshold character of the fission cross section.

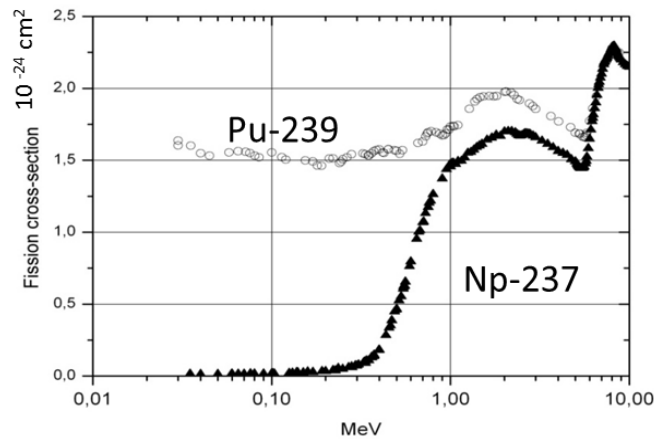

The character of the fission cross section of Np-237 and Pu-239.

The effective fission threshold (about 0.4 MeV) is below the fission threshold of U-238, and this makes it possible to create a critical mass of Np-237.

There are at least four important positive consequences of using neptunium in the core of a pulsed booster:

1. First, the lifetime of generation of fast neutrons  $\tau$  in the neptunium core is much lower than in the plutonium core (9 ns instead of 65 ns at IBR). In the optimum operating mode of the

booster, the multiplication factor of the neutron source is inversely proportional to  $\tau$ :  $M \cong \frac{\theta_{eff}}{\tau}$ .

Therefore, for a given width of the pulse of slow neutrons from the moderator,  $\Theta_{eff}$ , the neutron flux will be higher in the neptunium core.

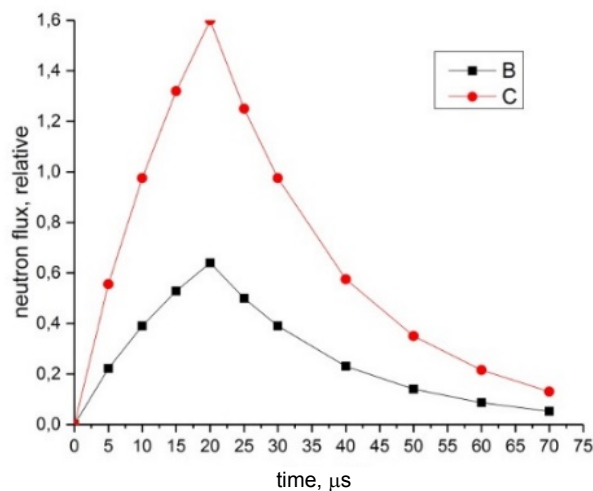

A qualitative comparison of short neutron pulses in the plutonium and neptunium core.

Red circles are the neptunium core, black squares are the plutonium core.

2. The background power of a pulsed source is proportional to the effective fraction of delayed fission neutrons,  $\beta_{eff}$ , which in the neptunium core is  $1.6 \cdot 10^{-3}$ , i.e. 1.4 times lower than for plutonium-239.

3. The third consequence of the threshold character of neptunium fission is the possibility of using neutron-moderating materials for the reactivity modulator. In the neptunium core, hydrogen, which is the best neutron moderator, "works" as a neutron absorber, removing them from the core. In this case, the change in reactivity is comparable to the insertion of a fissile material and considerably exceeds the effect from the movement of the reflector.

4. Neptunium nuclear fuel has one more remarkable property: in such a reactor there will be no reduction in the multiplication factor because of neptunium burnup, which is usual for uranium and plutonium reactors. This is explained by the fact that approximately one neutron out of the three emitted in the fission is captured by a neptunium-237 nucleus, to be followed by  $\beta$ -decay of a neptunium-238 nucleus and formation of a fissile isotope of plutonium:

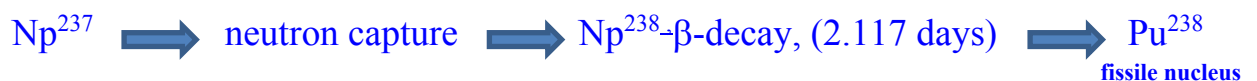

The accumulating Pu-238 participates in the fission process along with neptunium, and the neutron multiplication factor in the core practically does not change during the superbooster service life, as it is illustrated by the following figure.

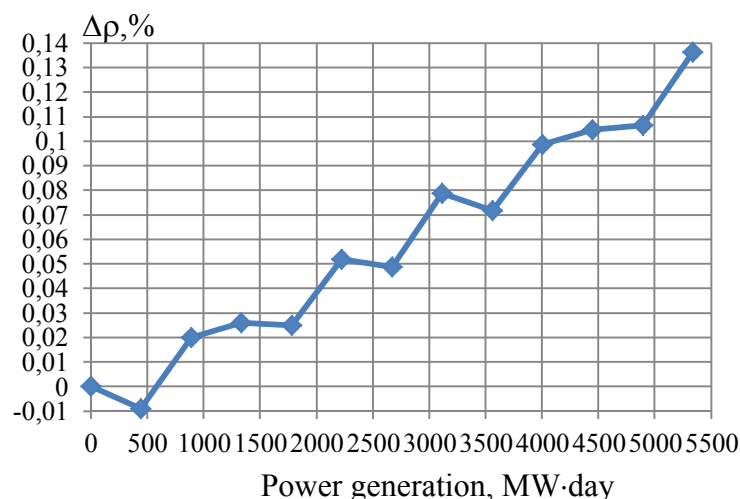

*The change of reactivity during the operation of the facility.*

5. It is also of importance that neptunium does not belong to weapons-grade materials.

$^{237}\text{Np}$  is an artificial isotope with a half-life of  $2.14 \times 10^6$  years and accumulates as a by-product in nuclear power reactors as a result of  $\beta$ -decay of uranium-237 (half-life 6.7 days), which is produced in fast neutron reactors in the (n, 2n) reaction on uranium-238 or by double capture on uranium-235 in thermal neutron reactors. One block of a water-water power reactor produces up to 13 kg of neptunium per year. Neptunium is one of the most significant wastes of atomic energy industry and at the same time – a potential nuclear fuel in compositions with plutonium. Actinide nitrides, and neptunium nitride in particular, have attractive properties for a nuclear fuel – high density and good thermal conductivity. Over the past two decades, properties of neptunium nitride have been rather extensively studied in respect to the problem of radioactive waste transmutation.

Some properties of neptunium nitride are listed in the following table:

	Neptunium nitride at 300 K	Neptunium nitride at 1500 K
Density, g/cm <sup>3</sup>	13.4	~13
Heat capacity, J/g/K	0.20	0.28
Thermal conductivity, W/m/K	~13	17,5
Coefficient of thermal expansion (linear), 1/K	$10^{-5}$	$1.5 \cdot 10^{-5}$
Modulus of elasticity, GPa	140	105

The point is that the flux density of a fission system for experiments with extracted beams is determined not by total heating power but specific energy removal, as illustrated in the figure.

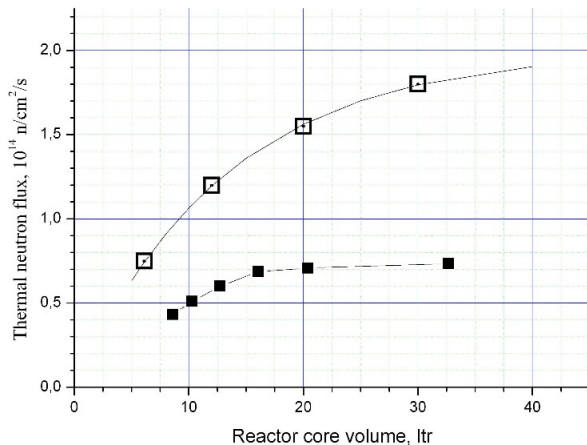

*Thermal neutron flux versus reactor core volume at given specific heat removal of 0.5 MW/l. Empty squares – for a sodium cooled fast reactor, black squares – for a reactor on epithermal neutrons (V.L. Aksenov, et al., Phys. Part. Nucl. Lett. 2017.V. 14, № 5. P.788-797).*

## Accelerator

A subcritical mode of superbooster operation presupposes the availability of an external pulsed source of neutrons with an energy of 1 – 10 MeV. The energetically favorable generation of such neutrons through the spallation reaction induced by protons with an energy in the region of 1 GeV (about 30 MeV of the proton energy goes to the formation of one neutron) is widely known and has long been used. In the core of the NEPTUN superbooster the spallation neutron multiplication factor is 200 – 500 times higher, which significantly lessens the requirements regarding the intensity of the proton beam. The parameters of the projected proton accelerator for NEPTUN are as follows:

- Energy of accelerated protons – 1.2 GeV;
- Peak proton current – 50 mA;
- Pulse repetition rate – 10 – 30 Hz, 30 Hz for short pulse mode;
- Proton pulse duration – 20 and 160  $\mu$ s;
- Proton beam power: peak – 60 MW, average – 12 ÷ 100 kW.

These parameters are not record-breaking and have already been achieved on linear proton accelerators of intense spallation neutron sources (e.g., SNS, Oak Ridge, United States). Depending on the speed of protons, which changes many times in the process of acceleration, different accelerating systems, which are most effective in the corresponding speed range, are used for acceleration. Superconducting resonators are employed in the greater part of the linear accelerator.

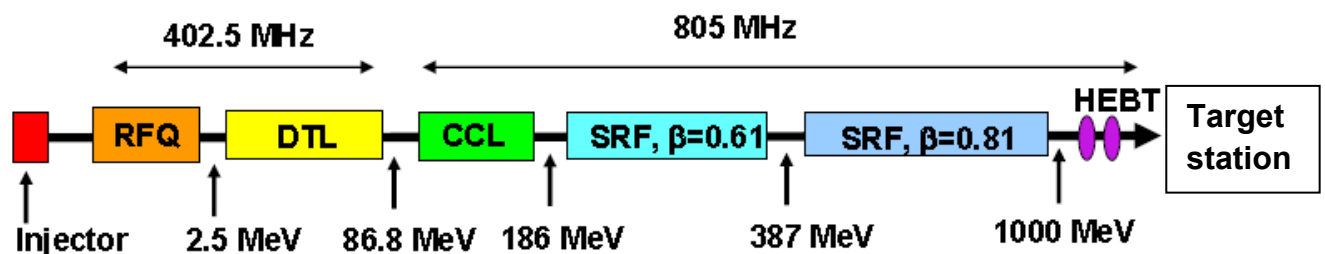

The figure shows a block diagram of the accelerator at SNS with the parameters exceeding the required parameters of the proton driver-accelerator of the NEPTUN superbooster. If a similar scheme is used, the NEPTUN superbooster accelerator will have an overall length of no more than 450 m. Accelerated protons are extracted from the accelerator via an evacuated channel, the bottom of which terminates immediately at the boundary of the core, and the protons are decelerated in the core material. The size of the proton beam at the entrance to the core should be at least 6 cm in diameter (to avoid overheating of fuel rods), so the beam will be made to diverge in the last few meters in front of the core.

### Core and heat removal

The core is an assembly of densely-packed fuel elements (FE), wherein the process of splitting of neptunium-237 nuclei by protons occurs followed by the fast process of chain reaction of fission of neptunium nuclei with the multiplication of target neutrons.



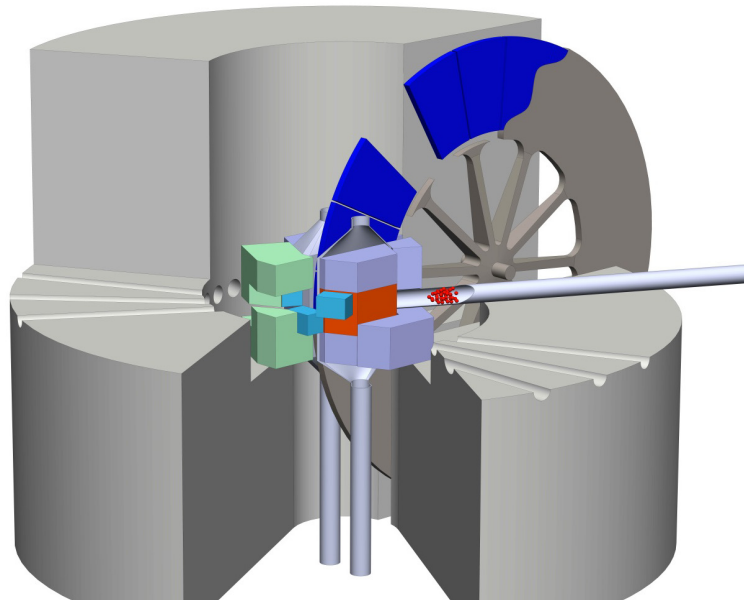

The core is placed in two identical stainless steel vessels, between which the reactivity modulator rotor passes.



*Scheme of NEPTUN with a sidelong arrangement of moderators (blue). Moderators are surrounded by a beryllium reflector (green). The reactivity modulator disk (dark blue – titanium hydride sectors) passes between two separate parts of the core surrounded by nickel reflectors (violet). A beam of accelerated protons (red balls) comes to one of them. The extracted neutron beams pass through channels in a concrete shield. The cap above the core is the coolant outlet.*



The fuel-element column is made of neptunium nitride and placed in a steel cylindrical tube with a gap to compensate for swelling of nitride during the burnup process, which (with a superbooster service life of 20 years) will amount to 10% of the fuel volume at 1500 K (7% burnup of heavy atoms). The gap between the column and the tube is filled with a liquid lead-bismuth alloy. The inner surface of the tube is clad with molybdenum to avoid radiation-induced corrosion.

		FE dimensions (diameter, layer thickness)	Celsius temperature (minimum- maximum)
Sodium coolant		$D_{\text{hyd}}=3 \text{ mm}$	250 – 450
Steel housing		0.35	270 – 480
Liquid-metal sublayer		0.3	300 – 510
Neptunium nitride		16	650 – 1210

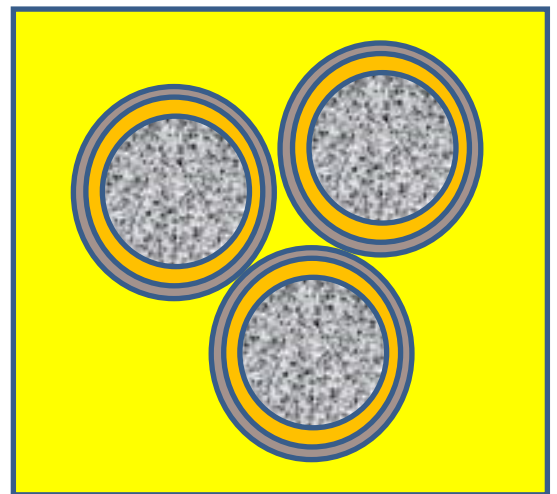

*Triangular unit cell for placing fuel elements, pitch 17.6 mm.*

The power density in the proton deceleration region increases by 20-30% (in the 60-kW beam power mode) as compared to the average power density of nuclear fission. To equalize it, the fuel-element columns in the proton deceleration volume ( $\sim 500 \text{ cm}^3$ ) can be produced from a mixture of neptunium nitride and uranium-238 (or tungsten) nitride.

Heat removal from fuel elements and nickel stationary reflector is done according to the scheme similar to that of the IBR-2 reactor, using liquid sodium (or potassium), which is fed to the vessels of the core from the bottom. The circulation of the coolant is carried out by magnetic induction pumps. A two-loop scheme prevents the release of radioactive sodium into the environment. The working temperature of sodium in the first loop is 250-450 °C, the coolant flow rate at a power of 10 MW is 180 m<sup>3</sup>/h.

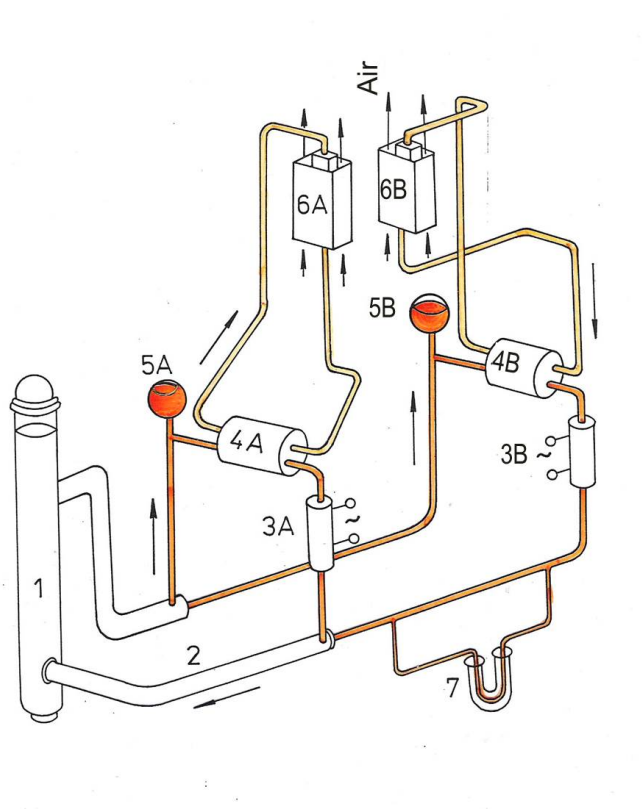

*Scheme of coolant loops. 1 – superbooster body (conventional representation), 2 – feed pipes, 3A and 3B – circulation pumps for the 1st and 2nd coolant loops, 4A and 4B – heat exchangers between the loops, 5A and 5B – expansion tanks, 6A and 6B – air heat exchangers.*

Fuel elements are grouped into assemblies of 3, 7 or 19 pieces in each, and in order to reduce the size of the core, the FE assemblies do not have cases similar to the design of the IBR-30 fuel elements and in contrast to the cassette design as in the case of the IBR-2M reactor.

The critical loading of the neptunium reactor at the maximum possible volume fraction of nitride of 72÷73% is estimated to be about 400 kg. The volume of the core is about 40 liters.

### **Reactivity modulator**

The main feature of the superbooster with neptunium is the reactivity modulator based on the replacement of a hydrogen-containing substance with a void.

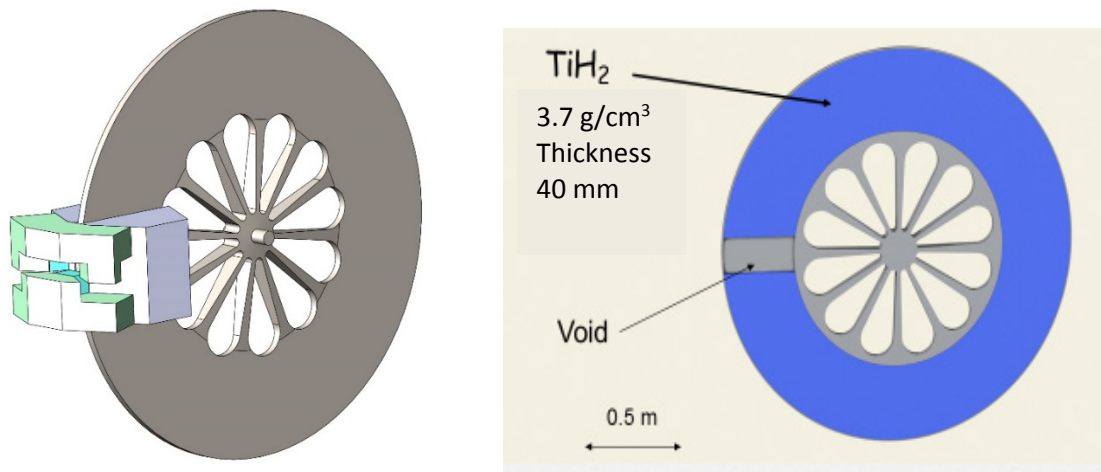

The modulator is designed in the form of a rotating disk with titanium hydride (density up to  $3.7 \text{ g/cm}^3$ ) shaped as radial sectors along its periphery. One of the sectors is empty; and when this sector enters the region of the reactor core, the neutron multiplication factor increases due to the hardening of the neutron spectrum. The rotation rate of the modulator rotor is 10 revolutions per second.

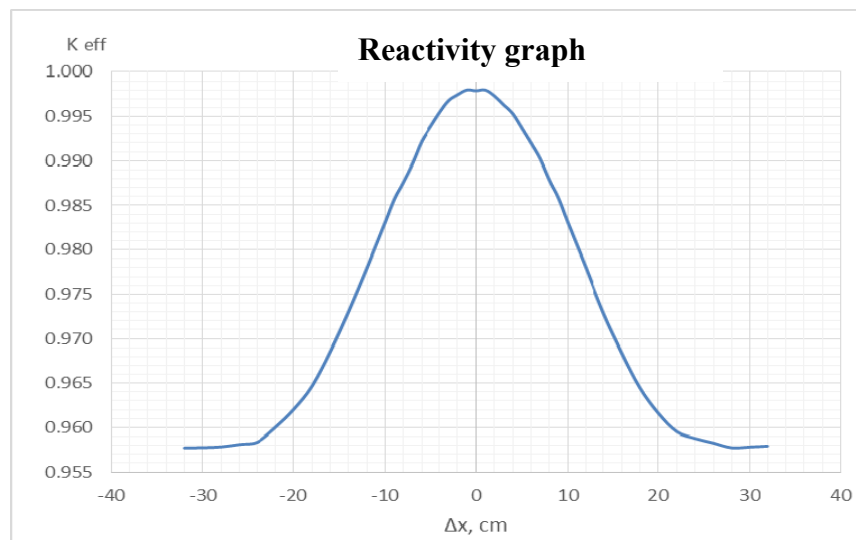

Graph of the modulator reactivity; in the region of  $\pm 5 \text{ cm}$  from the maximum the reactivity is described by a parabola with a parameter  $10^{-4} k_{\text{eff}}/\text{cm}^2$ .

The use of such a modulator provides deeper modulation of reactivity than a movable reflector (approximately by a factor of two). The reactor background power will amount to 3-3.5% of its average power.

Titanium hydride is a radiation-resistant material, which is well-studied and used in the biological shielding of nuclear power plants. A high hydrogen content in the hydride is maintained up to a temperature of 500 °C. The modulator is air-cooled. The heat load on titanium hydride in the sectors directly adjacent to the empty cavity is rather high – up to 3.5 W/cm<sup>3</sup> at a target station power of 10 MW. Therefore, to extend the service life of the modulator, the design of the disk allows periodical replacement of sectors with hydride, which during the reactor power pulse appear to be close to the core, with remote sectors.

### Moderators and instruments

The design of the target station has a wing-type geometry of arrangement of neutron moderators, i.e. moderators are arranged in such a way that the moderator surface is oriented orthogonally to the surface of the core. This measure reduces the flux of fast neutrons and gamma-rays in the direction of extracted beams about three times as compared to the radial arrangement of moderators at the IBR-2 for the majority of neutron beamlines. It is proposed to install three assemblies of moderators on two horizontal levels. Below is the scheme of arrangement of cold moderators on the upper level. The core is shown in red, the side nickel reflector in violet, moderators in blue, and rear beryllium reflector in light green.

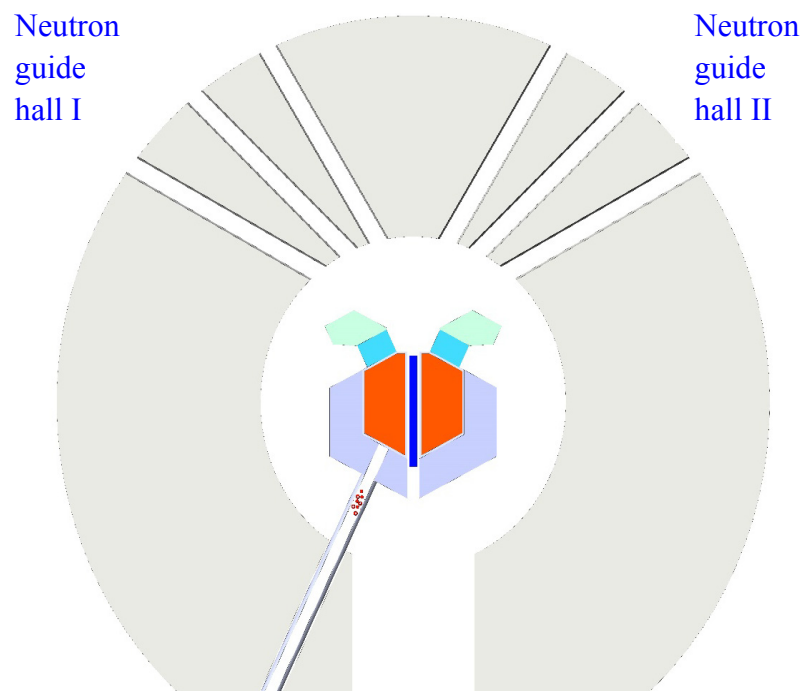

*Layout of moderators on the upper level.*

In this case, each assembly will have two working surfaces and can consist, correspondingly, of two different moderating media. This configuration of moderators makes it possible to provide no less than 14 neutron beamlines of different spectral composition and pulse width.

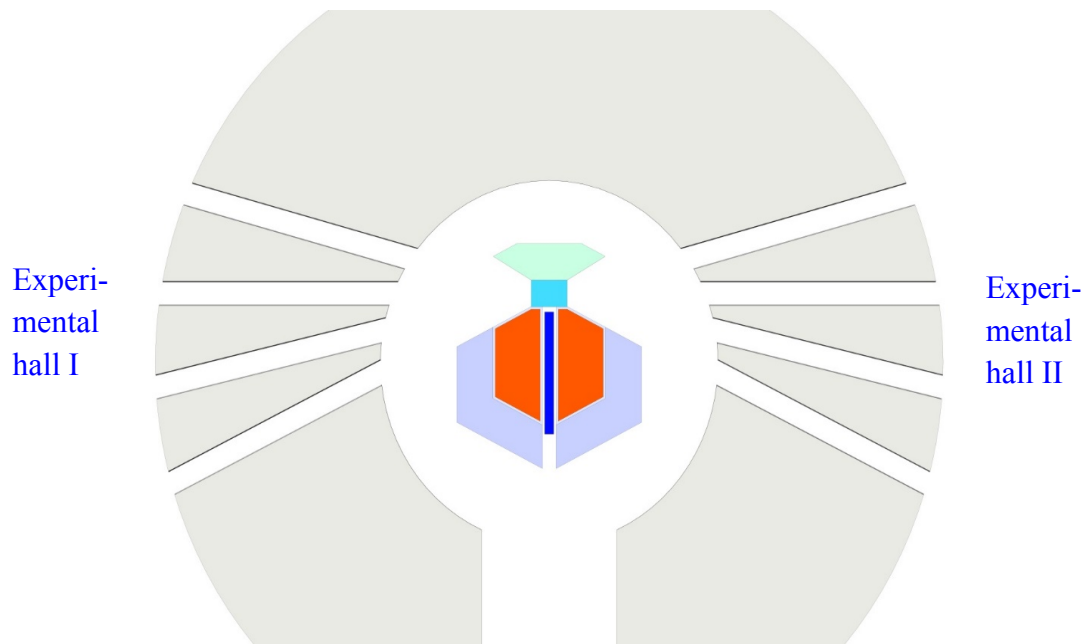

*Layout of moderators on the lower level.*

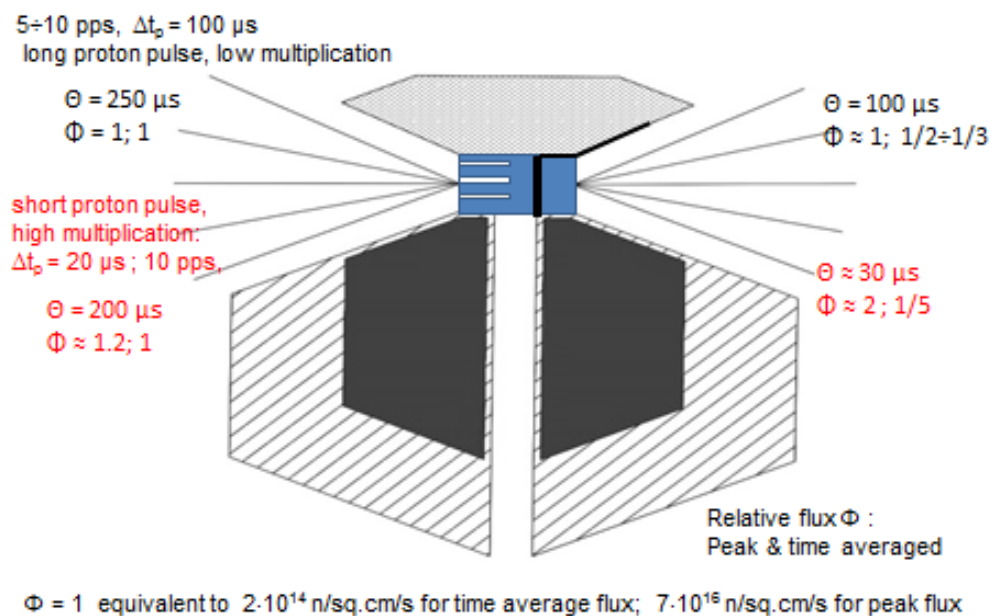

*Combined moderator with coupled and decoupled parts.*

In the short-proton-pulse (20  $\mu\text{s}$ ) operating mode of the accelerator, the width of the resulting thermal neutron pulse will be of the same order in a decoupled moderator, since the fast neutron pulse in the superbooster will not be delayed even at the maximum neutron multiplication factor of 500. In this case, the pulse of extracted neutrons from a decoupled moderator will correlate with the short lifetime of thermal neutrons, while with a usual grooved moderator the pulse will have a long trailing edge of the order of 200 – 250  $\mu\text{s}$ , maintaining a sufficiently high peak flux density of about  $5 \cdot 10^{16}$  n/cm<sup>2</sup>/s at an average flux density of up to  $1.5 \cdot 10^{14}$  n/cm<sup>2</sup>/s.

In the operating mode of the accelerator with a proton pulse of 160  $\mu\text{s}$ , the peak flux density with an unpoisoned coupled moderator will reach a limit value of about  $10^{17}$  n/cm<sup>2</sup>/s. Note that it is a limit value of the neutron flux density for any system using fission reaction (V.L.Aksenov, V.D.Ananiev, G.G.Komyshchev, A.D.Rogov, E.P.Shabalin, *Particles and Nuclei Lett.*, v. 14, N 5, 2017).

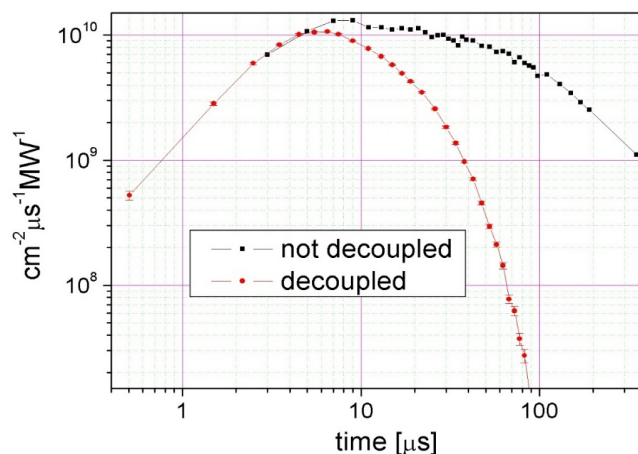

*Thermal neutron pulse shape from two surfaces of a universal moderator for a short-pulse mode of the accelerator. The upper curve (black squares) is an unpoisoned moderator (coupled geometry); lower curve (red circles) - decoupled geometry with a Gd layer placed at a distance of 2 cm from the surface.*

Thus, the NEPTUN superbooster will be a universal neutron source providing the best conditions for conducting experiments simultaneously on all spectrometers.

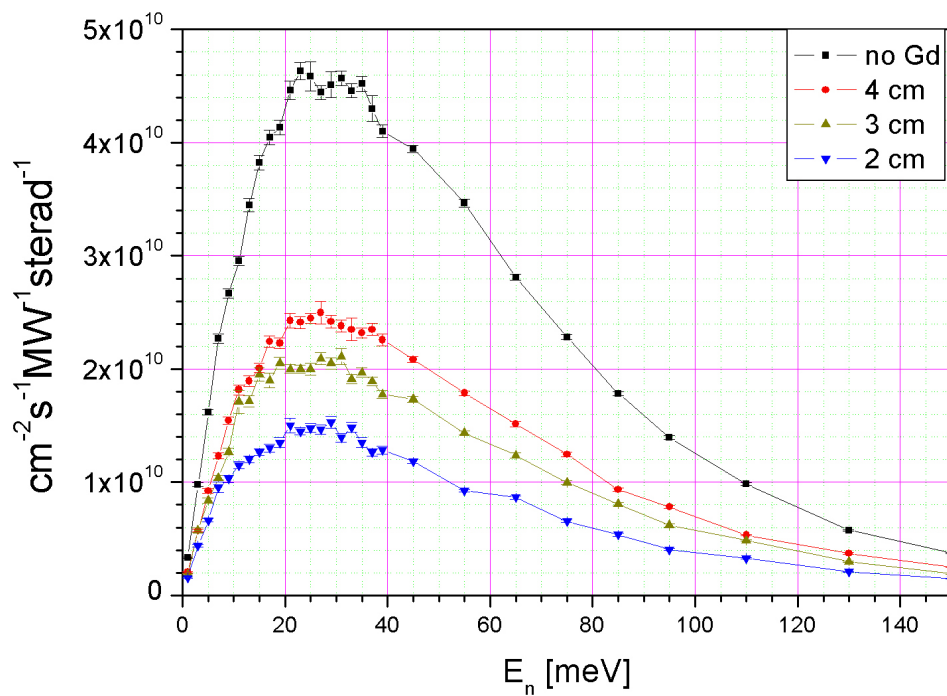

*Spectrum of the vector flux of thermal neutrons from the surface of a flat water moderator without gadolinium poisoning (upper curve) and with a gadolinium layer at a distance of 4, 3 and 2 cm from the surface.*

There are two cold moderators on the upper level with three channels each. Cold moderators at temperatures  $T_m = 30$  and  $60$  K will produce neutrons with a long pulse duration ( $\theta \approx 250 \mu\text{s}$ , LP). These channels will lead to two neutron guide halls. The neutron guide hall I is planned for 4 small-angle scattering instruments and 2 diffractometers, 1 neutron radiography and tomography and 1 spin-echo spectrometer. The neutron guide hall II is designated for 4 reflectometers, 1 diffractometer, 1 inelastic scattering and 2 ultracold neutron facilities.

A combined moderator for thermal neutrons will be placed on the lower level. This moderator will produce LP neutrons in the case of LP ( $160 \mu\text{s}$ ) operation of the proton accelerator. In the case of SP ( $20 \mu\text{s}$ ) operation there are two possibilities: moderator I (unpoisoned) for LP ( $\sim 200 \mu\text{s}$ ) neutrons and moderator II (poisoned) for SP ( $\sim 30 \mu\text{s}$ ) neutrons. In the case of LP accelerator regime all instruments will use only LP neutrons. In the case of SP accelerator regime there will be a possibility to use SP neutrons. In this case, the experimental hall I will host 6 instruments for nuclear and particle physics research and 2 diffractometers. The experimental hall II will be equipped with 3 diffractometers and 3 inelastic scattering spectrometers, 1 neutron radiography and tomography and 1 spin-echo spectrometer.

The Table summaries the instruments mentioned above.

Small-angle scattering:	4, cold neutrons, LP
Reflectometers:	4, cold neutrons, LP
Diffractometers:	3, cold neutrons, LP
	2, thermal neutrons, LP
	3, thermal neutrons, SP
	1, cold neutrons, LP
Inelastic scattering:	3, thermal neutrons, SP
Radiography and tomography:	1, cold neutrons, LP
	1, thermal neutrons, SP
Spin-echo (elastic)	1, cold neutrons, LP
Spin-echo (inelastic)	1, thermal neutrons, SP
Ultracold neutron facilities:	2, LP
Nuclear and particle physics:	6, LP
Total:	Condensed matter: 24
	Nuclei and particles: 8

At the first stage the following instruments are under consideration. There are three possibilities: high resolution (HR), medium resolution (MR) and low resolution (LR).

#### Diffractometers

High-resolution structures	HR
Real-time diffraction	MR
High pressure	MR
Texture	HR
Single crystals	MR
Radiography and tomography	HR, HR

#### Small-angle scattering

General-purpose, $Q = 0.001 - 1 \text{ \AA}^{-1}$ ,	LR
Extended, $Q = 0.002 - 1.5 \text{ \AA}^{-1}$ ,	LR
USANS, $Q = 0.00001 - 0.01 \text{ \AA}^{-1}$ ,	LR

#### Reflectometers

Polarized neutrons	LR
Liquids	LR
Large-scale structures	LR

#### Inelastic scattering

Inverse geometry	HR
Direct geometry HR	HR
Direct geometry MR	MR
Spin-echo elastic	HR
Spin-echo inelastic	HR



## Nuclear safety

An important point in the assessment of the safety of a target station is the reaction to fast significant perturbations of reactivity. In the case of using a neptunium core as a neutron-producing target of a proton accelerator (superbooster mode), the effect of reactivity fluctuations on pulse energy is a hundred times weaker:

– pulse energy change at the pulsed IBR-2M reactor under perturbations of reactivity  $\rho_n$

$$Q_n / Q_0 \approx \exp(\rho_n / \beta_{\text{pulse}}), \quad \beta_{\text{pulse}} = 1.4 \cdot 10^{-4}$$

– pulse energy change at the Neptunium superbooster

$$Q_n / Q_0 \approx 1 / (1 - M \cdot \rho_n), \quad M - \text{multiplication factor of target neutrons in the booster.}$$

According to the formulas, the reactivity perturbation of  $10^{-4} k_{\text{eff}}$  gives a two-fold increase in the peak flux of the IBR-2 reactor, and in the superbooster at the maximum multiplication factor of 500 – only a 5% increase. Under a significant perturbation of  $10^{-3} k_{\text{eff}}$ , the IBR-2 peak flux will increase by 3 orders of magnitude (disturbing pulse), while for the superbooster – only by a factor of 2. It is important to note that reactivity perturbations exceeding  $10^{-4} k_{\text{eff}}$  have never been observed during the whole period of operation of IBR-2 and IBR-2M.

A proton current of the accelerator will play a leading role in the generation of neutron bursts. A short-term loss of proton pulse leads to a decrease in temperature and, accordingly, to an increase in reactivity. In order to avoid an increased power pulse when the proton beam is restored, it is intended to maintain double control over the situation: inhibition of acceleration in the case of absence of the beam for a certain time and lowering of reactivity by a regulating unit at a specified rate, which excludes the generation of an emergency pulse when the proton beam is restored. **Operational stability of the accelerator is the key to stable operation of the superbooster.**

A distinctive feature of the neptunium superbooster is that the chosen type of the reactivity modulator cannot in principle cause positive reactivity insertion in the case of any malfunctions and failures due to the position in the region of maximum reactivity, as well as the radial symmetry of the disk. It is also of importance that compact titanium hydride does not ignite. The safety of the facility is also largely determined by a practically zero effect of

reactivity when discharging the coolant from the core. Only the discharge of water from moderators results in a positive reactivity effect owing to the hardening of neutron spectrum, but due to the presence of a beryllium reflector this effect is not so significant – on the order of 0.01%  $k_{\text{eff}}$ .

To control the superbooster, movable elements on the side nickel reflector (which provide up to 1.5% of reactivity compensation) will be used. The function of the emergency safety system will be performed by beryllium reflector blocks.

A high level of nuclear safety of the superbooster becomes particularly evident when comparing the level of criticality of the chain reaction in the stationary research reactor PIK, the periodic pulsed IBR-2M reactor and the NEPTUN superbooster (see figure on p. 22 in Section “Why a superbooster?”).

**Table. Basic parameters of NEPTUN superbooster**

Thermal neutron flux density, time-averaged:	$(0.5 \div 2) \cdot 10^{14} \text{ n cm}^{-2} \text{ s}^{-1}$ , depends on position and type of moderator
Peak density of thermal neutron flux:	$(4 \div 9) \cdot 10^{16} \text{ n cm}^{-2} \text{ s}^{-1}$
Half-width of fast/thermal neutron pulse:	from 20 to 250 $\mu\text{s}$ depends on proton pulse width and moderator type
Pulse repetition rate:	10 $\div$ 30 Hz
Background power (percentage of the average)	3.2 %
Number of neutron beamlines	20 – 32
Thermal power	up to 15 MW
Fuel elements	tubular cylindrical FE with a column 16 mm in diameter
Maximum fuel temperature	1500 K
Coolant temperature	250 – 450 °C
Coolant flow rate	up to 180 m <sup>3</sup> /h
Reactor service life (in respect to fuel burnup)	20,000 – 25,000 MW/days
Neptunium nitride loading	about 400 kg
Maximum positive reactivity feedback (water discharge)	0.01% $k_{\text{eff}}$
Total efficiency of reactivity modulator	4.4 % $k_{\text{eff}}$
Prompt neutron generation lifetime	10 ns
Effective fraction of delayed neutrons	$1.6 \cdot 10^{-3} k_{\text{eff}}$

# Road map and costs



## Road map and costs

This Section provides conclusions for the presented short description of the NEPTUN conceptual research. It was carried out in the Frank Laboratory of Neutron Physics of JINR in cooperation with the Dollezhal Research and Development Institute of Power Engineering, which performed the engineering design of all reactors in Dubna.

The next steps for the realization of NEPTUN are as follows:

- technical study;
- R&D phases;
- engineering design;
- construction phase;
- start of facility operation.

The following timetable is suggested:

## Road Map (Preliminary): 2015 - 2035

Activity	2015 – 17	2018 – 20	2021 – 23	2024 – 26	2027 – 32	2032 – 35
Conceptual research	2015 – 17					
Technical study		2018 – 20				
R & D			2021 – 23			
Engineering design				2024 – 26		
Construction					2027 – 32	
Commissioning						2032 – 35

The technical study has identified several areas at the frontiers of existing technology where R&D is needed. High-priority areas involve the development of a target station, neptunium nitride fuel elements, thermal stress and radiation effects in target materials, moderators, accelerators, neutron instruments.

The goals of the R&D phase are to provide the database for the engineering design and prepare the technical and economic basis for a final conclusion about the construction of the NEPTUN which would minimize costs and technical risks.

The main expected results of the R&D phase will be:

- resolution of key technical issues which have been identified;
- validated database for the engineering design;
- accurate cost estimate;
- determination of site requirements and safety aspects, including licensing issues;
- timetable and budget profile for construction.

It is an important point to make a site-independent (green field) cost estimate for construction and operation of NEPTUN. The preferable place for the new neutron source would be nearby the IBR-2 reactor as it will make it possible to use the existing engineering infrastructure and reduce the total cost. We should add to the total cost the above-mentioned staff costs for construction and development phases. It will account for some 20% of this total.

The annual running costs are estimated on the basis of exploitation experience of the IBR-2 reactor and JINR accelerators. The estimate amounts to 30 M€ including 500 staff and power consumption costs.

An initial cost estimate of the project and construction of the accelerator-driven source can be made on the basis of already implemented projects in other scientific centers such as ISIS, SNS, JSNS, as well as ESS (under construction).

	M€
Proton accelerator of 1.2 GeV with a peak current of 50 mA	200
Target station	150
Complex of cold moderators	50
Neutron beam instrumentation	100
R&D	20
Engineering infrastructure	50
<b>Total:</b>	<b>570</b>

Road map and costs

The construction of NEPTUN will bring new opportunities and challenges for industries of JINR Member States, especially related to nuclear power industry sectors. We believe that the return for science and technology which NEPTUN can deliver during 40 years of its expected service life will be more than sufficient to justify the commitment of funds.

	Moderator type	Peak differential neutron flux $10^{14}$ n/cm <sup>2</sup> /s/sr/Å (Brightness)	Peak neutron flux, $2\pi$ eqv. $10^{14}$ n/cm <sup>2</sup> /s	Time averaged flux $2\pi$ equivalent. $10^{14}$ H/cm <sup>2</sup> /c
IBR-2	Grooved, wide	9	58	0.09
	Grooved, height 4.5 cm	12	77	0.16
J-Park	Coupled	10	65	0.3
ESS	Butterfly height 6 cm	8	50	2.0
	Height 3 cm	12	75	3.0
PIK, Russia	Stationary, D <sub>2</sub> O moderator	1.6	12	12
NEPTUN	Grooved	130	800	2.0

Comparison of NEPTUN with other sources (basic figure from the ESS report).

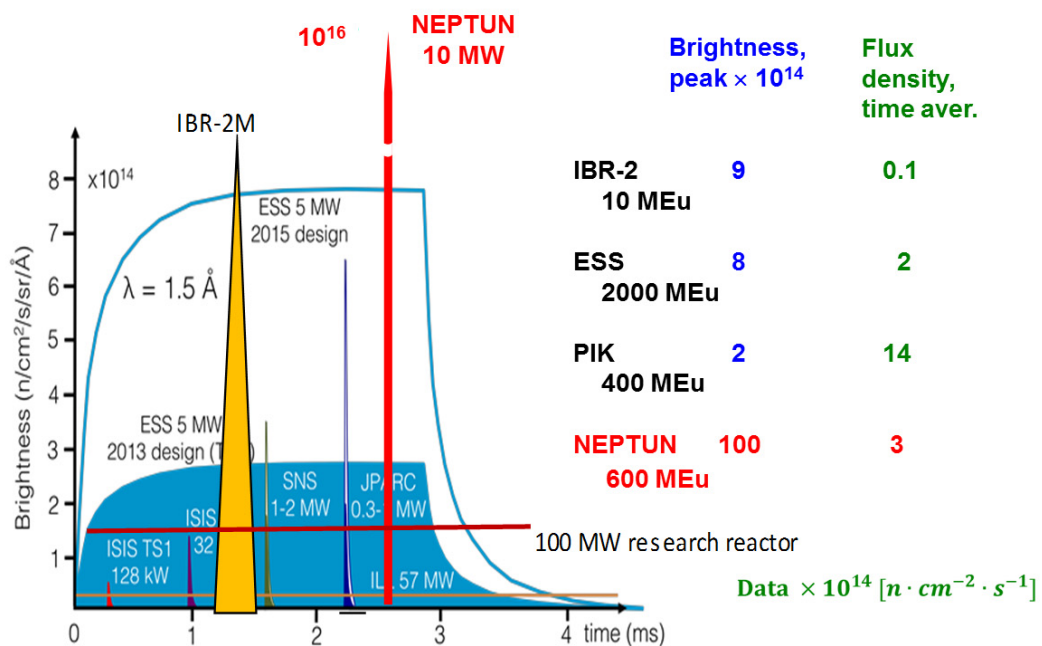

## **Appendix**

# **Brief history of Dubna neutron sources**

### First generation – IBR reactor

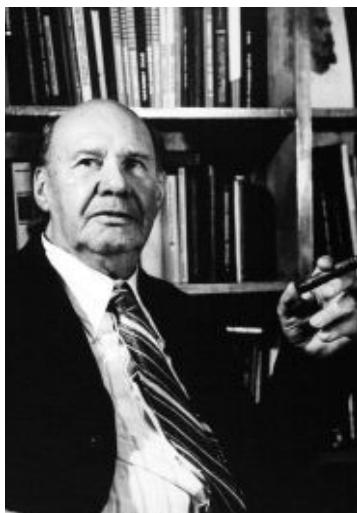

**D.I. Blokhintsev**  
(1908 – 1979)



**I.M. Frank**  
(1908 – 1990)



**F.L. Shapiro**  
(1915 – 1973)

In 1955, physicists from Obninsk (Russia) under the supervision of D.I. Blokhintsev, who in 1956 became the first Director of the Joint Institute for Nuclear Research in Dubna, proposed a new type of nuclear reactor—fast pulsed reactor (IBR) of periodic operation—which generated neutrons in pulses at a pulse frequency necessary for conducting experiments. The first reactor of this type was put into operation at JINR on June 23, 1960.

In parallel with the construction of the reactor at the Laboratory of Neutron Physics a physical research program was developed under the guidance of I.M. Frank and F.L. Shapiro. The results of first experiments were published in 1961.



**The photo shows the world's first research pulsed fast neutron reactor of periodic operation (IBR).**

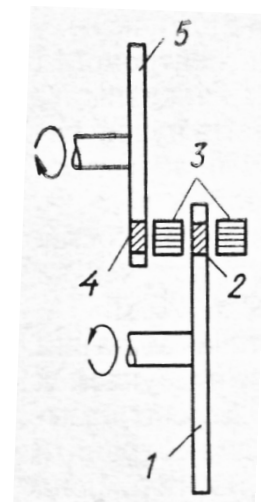

**Schematic diagram of IBR.** 1 – reactivity modulator disk; 2 – uranium insert (main movable core); 3 – two parts of plutonium core; 4 – uranium insert (additional movable core); 5 – additional reactivity modulation disk.



## Second generation

### Reactor IBR with microtron injector (superbooster)

Since for neutrons with  $E \geq 2$  eV the uncertainty of their migration in a water moderator is  $\Delta t = 1.2/\sqrt{E} \leq 1 \mu\text{s}$ , the IBR reactor with a pulse width (before moderator) of  $\sim 50 \mu\text{s}$  was not optimal for nuclear physics. Therefore, soon after the commissioning of the IBR reactor, it was decided to use a booster system proposed in Harwell (UK) in 1959, and since 1964 the IBR reactor started to be used as a photonuclear superbooster in combination with an electron accelerator (microtron). The reactor played the role of a multiplying target with reactivity modulation synchronized with the accelerator pulse. In 1971, a group of authors including D.I. Blokhintsev, I.M. Matora, S.K. Nikolaev, V.T. Rudenko, I.M. Frank, E.P. Shabalin, F.L. Shapiro (JINR), I.I. Bondarenko, F.I. Ukraintsev (IPPE), I.S. Golovnin (Kurchatov Institute), G.E. Blokhin (CIAM) were awarded the USSR State Prize for "IBR research reactor and IBR reactor with an injector".

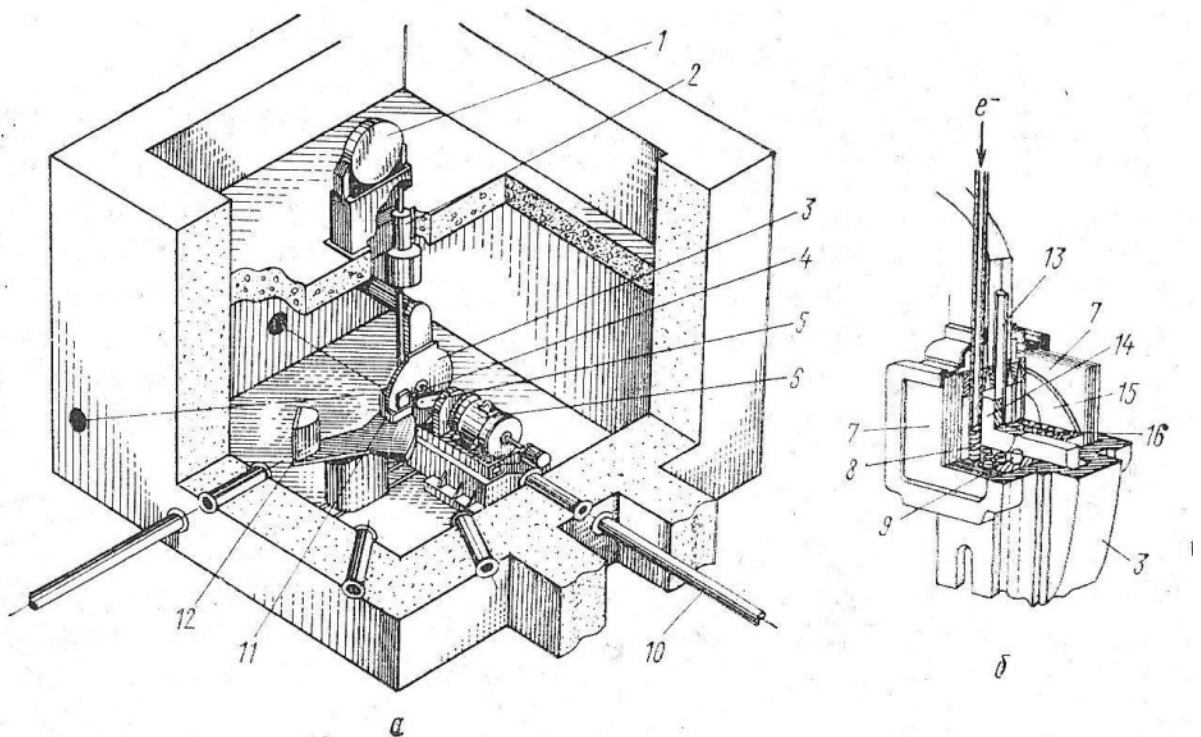

**IBR with microtron in the hall.** 1 – microtron, 2 – focusing lenses, 3 – jacket of main movable core, 4 – core, 5 – mechanical transmission, 6 – engine, 7 – neutron reflector, 8 – electron target, 9 – control rod, 10 – neutron guide, 11 – moderator, 12 – lead shield, 13 – rotating disk, 14 – main movable core, 15 – auxiliary movable core, 16 – plutonium fuel elements.

## IBR-30 reactor with an injector (superbooster)

The average power of the first IBR reactor was initially low – 1 kW, later 6 kW. However, the peak power at a repetition rate of 8 pulses per second amounted to 3 and 18 MW, respectively, while in the mode of rare pulses (once every 5 s) it was up to 400 MW. In 1968, IBR was shut down, and a new reactor of the same type (IBR-30) with an average power of 25 kW took its place in 1969. The flux of thermal neutrons in the pulse amounted to  $10^{14}$  n/cm<sup>2</sup>·s. However, the relatively long pulse of 60 μs provided a resolution 60 times lower than it was required.

In 1969, a more powerful linear electron accelerator with a pulse current of 200 mA and pulse duration of about 1 μs was installed in place of the microtron. A tungsten target was placed in the reactor core (I.M.Frank, Particles and Nucleus, v. 2, N 4, 1972). Until 1996, the IBR-30 reactor operated in two modes: as a pulsed reactor and pulsed superbooster. From 1996 and until 2001 the IBR-30 operated only as a booster-multiplier with a pulse frequency of 100 pulses per second, an average power of the multiplying target of 12 kW, and a pulse half-width of 4 μs. Since 1994, JINR has been developing a project for a new pulsed neutron source IREN making use of an electron linear accelerator and a multiplying target (V.L.Aksenov, N.A.Dikansky, V.L.Lomidze, A.V.Novokhatsky, Yu.P.Popov, V.T.Rudenko, A.N.Skrinsky, W.I.Furman, JINR, E3-92-110, Dubna, 1992). At present, the first stage has been completed (without a multiplying target).

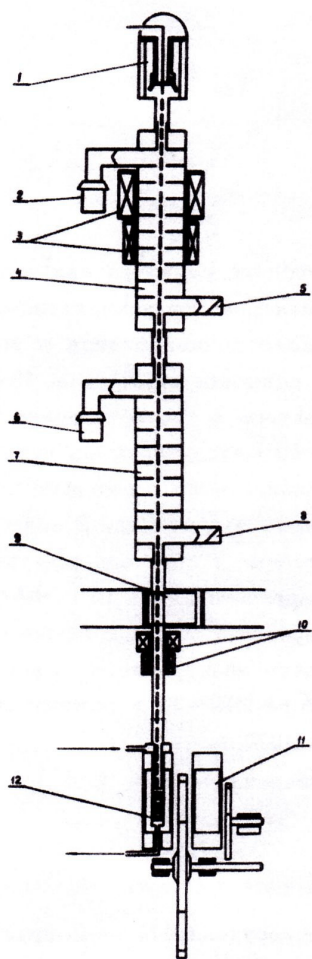

**Schematic diagram of IBR-30 with an injector – linear electron accelerator.**

- 1 – electron gun;
- 2, 6 – klystrons;
- 3 – focusing solenoids;
- 4, 7 – diaphragmed waveguides of sections № 1 and № 2;
- 5, 8 – water loads;
- 9 – vacuum protective shutter;
- 10 – quadrupole lenses;
- 11 – IBR-30 core;
- 12 – neutron-producing target.

## Third generation

### IBR-2 reactor

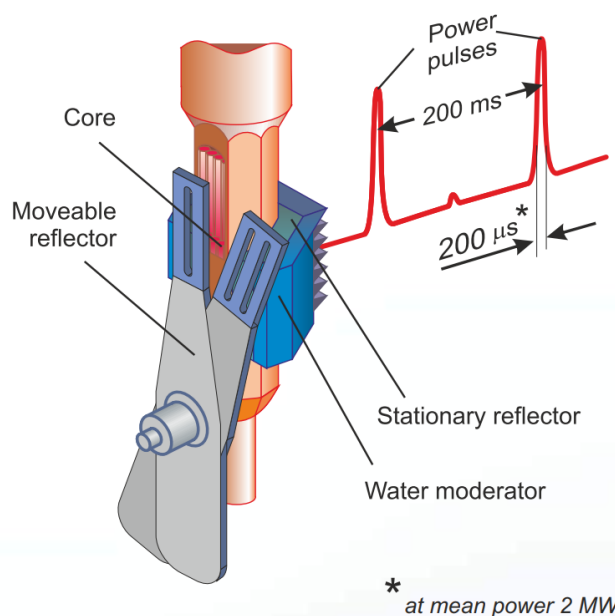

The successful operation of the IBR reactor and its modified variants gave impetus to further progress in this field. In the middle of the 1960s, a few more projects were initiated. First, the construction of the pulsed SORA reactor with a movable reflector (average power 600 kW) was reported. The reactor was to be built at the Euroatom Research Centre, Ispra, Italy. A high-power periodic pulsed reactor (average power 30 MW) was projected at the Brookhaven National Laboratory, USA. In 1964, the work on a new IBR-2 project was started in Dubna (E.P. Shabalin, *Pulsed Fast and Burst Reactors*, Oxford: Plenum, 1979). This reactor was different from the first facilities of the IBR series in that its reactivity was modulated by a movable reflector and in cooling the core by liquid sodium. A linear induction electron accelerator (LIU-30) with an energy of 30 MeV and a pulse current of 250 A was planned as an injector. The LIU-30 project failed to be implemented, and it was stopped in 1989, therefore the IBR-2 facility operates as a pulsed reactor. Of all the proposed projects of high-flux pulsed reactors, only the IBR-2 project was implemented, which became possible owing to the previous experience in operating such systems in Dubna and Obninsk and to the active participation of the Ministry of Medium Machine-Building Industry of the USSR. Besides JINR and the Institute for Physics and Power Engineering (IPPE) (Obninsk, Kaluga region) a number of institutions of the USSR Ministry of Medium Machine-Building Industry took part in the construction of the IBR-2 reactor. The main designing institution was the Research and Development Institute of Power Engineering, development work was carried out by the State Specialized Design Institute, fuel elements were manufactured by the All-Union (at present, All-Russian) Research Institute of Inorganic Materials and the Mayak industrial complex. To solve specific technical problems, other specialized institutions and design bureaus of the Ministry were recruited as well. It can be asserted that the creation of pulsed reactors represented one of the most striking manifestations of the highest potential of nuclear science and technology in this country.

### Third generation

Officially, work on the IBR-2 project started in 1966, and actual construction – in 1969. The first critical assembly was manufactured at IPPE in 1968, and from 1970 to 1975 the model of the movable reflector was investigated at a test bench in Dubna. The physical startup of the reactor (without a coolant) was conducted 8 years after the start of the construction (in late 1977 – early 1978). Then the preparation and implementation of power startup (with sodium) began, which was actually completed on April 9, 1982, when the average power attained was 2 MW for a pulse repetition rate of 25 Hz, and first physical experiments were performed with extracted beams. After the death of D.I.Blokhintsev in January 1979, I.M.Frank became the scientific supervisor of IBR-2. Officially, the reactor was commissioned on February 10, 1984, and the implementation of the program of physical experiments started on April 9, 1984 after the power reached 2 MW at a pulse frequency of 5 Hz (V.L.Aksenov, Physics – Uspekhi, v. 52 (4), 2009).

Reactivity modulation was realized by a steel movable reflector consisting of two parts rotating with different velocities (1500 and 300 revolutions per minute). When both parts of the reflector traversed the core, a power pulse was generated (1500 MW). At a regular mode of operation of the reactor (2500 hours for experiments per year) the service life of the core without fuel exchange was expected to be no less than 20 years, the service lifetime of the movable reflector — 5-7 years. In 1995, IBR-2 started operating with a new movable reflector (the third in succession), and in 2004, a nickel reflector of complex configuration was installed, the expected service life of which is 25 years. In 2011, the modernization of the IBR-2 reactor was completed — a long program of scientific and technical work — in fact, the creation of a new reactor in the same building. It was started only in 2000 due to the financial support of the Ministry of Atomic Energy of the Russian Federation (successor to the Ministry of Medium Machine Building Industry of the USSR) and with the personal support of Minatom Minister E.O.Adamov. The new IBR-2M reactor with improved parameters and modern safety control systems has been operating for users since 2012.



**The 22-liter core of IBR-2 with a plutonium dioxide fuel with a critical mass of about 90 kg was placed in the reactor vessel.**



**Reactor hall of IBR-2.**

Thus, the pulsed IBR-2 reactor is an economical, relatively cheap and, as revealed by the experience of operation, a simple and safe device to operate. The design and construction of IBR-2 cost about 20 million rubles (measured in 1984 rubles). Nowadays, the operation, further development, and improvement of the reactor cost less than 1 million US dollars per year. This is 10-50 times less than for other modern neutron sources in the world. At the same time, the reactor provides a neutron flux of  $10^{16}$  n/cm<sup>2</sup>/s, which is a record high for research neutron sources.



In 1996, for the creation of the research high-flux pulsed reactor IBR-2, the Prize of the government of the Russian Federation in the field of science and technology was awarded to the team of authors: V.D.Ananiev, D.I.Blokhintsev, B.N.Bunin, V.L.Lomidze, I.M.Frank, E.P.Shabalin, Yu.S.Yazvitsky (JINR), M.V.Vorontsov (GSPI), V.S.Sizarev, V.S.Smirnov, N.A.Khryastov (NIKIET).

**In the photo from right to left:  
D.I.Blokhintsev, V.D.Ananiev, E.P.Shabalin.**



**IBR-2  
experimental  
hall**

In 2000, the State Prize of the Russian Federation in the field of science and technology was awarded to a group of authors including: V.L.Aksenov, A.V.Balagurov, V.V.Nitz, Yu.M.Ostanevich (JINR), V.P.Glazkov, V.A.Somenkov, (NRC “Kurchatov Institute”), V.A.Kudryashev, V.A.Trunov (Petersburg Nuclear Physics Institute of NRC “Kurchatov Institute”) for the development and implementation of new methods of structural neutron diffraction by the time-of-flight technique using pulsed and stationary reactors.





